

VON DUPRIN®

INPACT™ 94 AND 95 Series Exit Device

 **IR Security & Safety**

America's most preferred exit devices.

Von Duprin exit devices are famous for their innovative design and meticulous engineering. There's simply no substitution. That's why Von Duprin can be found at Caesar's Palace in Las Vegas, and is the preferred choice for many other businesses and public institutions throughout North America.



*COOPERS ELEMENTARY SCHOOL,
ELM CITY, NC*



THE UNQUESTIONED LEADER IN INNOVATION, DESIGN AND DURABILITY.

Von Duprin invented the exit device in 1908. Since that time, there have been many imitators, but no other true innovator. The unique, streamlined Von Duprin INPACT recessed exit device is a perfect example of how creative thinking and great engineering can turn a safety necessity into a stylishly understated fixture.

INPACT is fully integrated within a door and combines a clean, tasteful appearance with Von Duprin's unrivaled standards of durability and performance. The design is compatible with hollow metal doors, including doors manufactured by Steelcraft®, part of the IR Security & Safety product line.

GRACE UNDER PRESSURE.

Available in a variety of finishes, INPACT is UL® approved to meet the strictest building codes. The fact is, UL® testing sets an important standard for the industry. But at Von Duprin, our testing goes well beyond industry standards to make absolutely sure our exit devices will survive in the real world. For this reason, INPACT will withstand repeated abuse and continue to perform, even in the most demanding environments. You can be totally confident that every Von Duprin product you specify or install will exceed your expectations for reliable operation and long-lasting durability.



*NASH HEALTH
CARE SYSTEMS,
NASH GENERAL
HOSPITAL,
ROCKY MOUNT, NC
Nash General Hospital
is among a small
percentage of hospitals
nationally to receive the
honor of Accreditation
with Distinction.*



THE FULL LINE OF INPACT RECESSED EXIT DEVICES FOR SINGLE AND DOUBLE DOOR APPLICATIONS.



INPACT's low profile design makes it the perfect application for healthcare facilities, schools, corporate campuses, theaters, hotels, stadiums and art museums.

The clean, versatile design blends with an infinite variety of decors. With its wide pushpad, operation is easy for everyone, including people with disabilities. Recessed in the door, INPACT maintains a low-profile which makes it ideal for corridor doors. Minimal projection provides more room for people and equipment to pass. And, when an object such as a cart or dolly collides with the device, the sloped endcaps deflect the object away from the door, protecting the device and the door.



*Photograph of INPACT
devices on Steelcraft
Graintech™ steel doors.*

All INPACT exit devices are as durable as they are beautiful. The heavy-duty construction, simple mechanical design and Von Duprin's legendary commitment to quality combine to ensure a long, trouble-free service life.

DESIGN

The streamlined, extruded aluminum pushpad is uniquely designed to exhibit grace under pressure. Built to absorb shock, it takes the wear and tear of even the most demanding high-traffic areas. The sloped, die-cast metal endcaps provide added support, protecting the device and the door against the heaviest impact. The nonhanded configuration simplifies installation and gives superior flexibility in the field.

CONSTRUCTION

Beneath the beautiful architectural design includes a number of durable mechanical components and characteristics. Compression springs are used throughout, and all internal components are coated with zinc dichromate to prevent corrosion. Latchbolts have a self-lubricating coating to reduce friction and wear. Concealed studs and through-bolts, from the inside, fasten the heavy-duty outside trim. Factory steel door prep makes installation simple and fast. Not available on wood doors.

DURABILITY & RELIABLE OPERATION

Devices are tested in accordance to ANSI/BHMA A156.3 Grade 1 by a BHMA certified testing laboratory. INPACT has exceeded one million cycles.

Factory steel door preparation makes installation simple and fast. Photograph of Graintech™ steel door by Steelcraft.



VON DUPRIN® *INPACT™* Appearance and Trim Options

PUSHPAD DESIGN OPTIONS



94 Series - Smooth Pushpad



95 Series - Grooved Pushpad

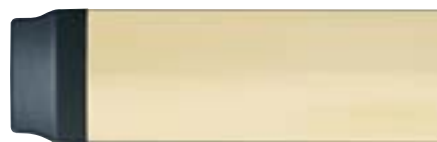

US3 *Brass, Polished*



US26 *Chrome, Polished*

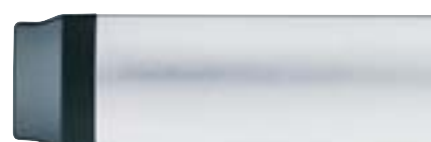

US28 *Aluminum, Anodized*



US4 *Brass, Satin*



US26D *Chrome, Satin*



313 *Duranodic Dark Bronze*



US10 *Bronze, Satin*

Von Duprin INPACT devices are available in seven attractive finishes to complement any job, as well as the option of a sleek, smooth pushpad and a unique, grooved pushpad. The durable die-cast aluminum endcaps are available in standard black and matching or contrasting powder coated finishes.

STANDARD TRIM

L



Lever LP373L*

Forged brass 1-3/8" (35mm) depth escutcheon. #06 lever is standard. Optional lever designs are available.

* Blank escutcheon "BE" available.
Example: LP373L-BE.

OPTIONAL TRIMS

DT



Dummy Pull 550DT

Heavy aluminum forged brackets with 10" (254mm) stainless steel pullbar.

TL



Thumbturn 376T

Forged brass 7/8" (22mm) escutcheon. It is often used with a 550DT pull trim.

Only available with concealed rod devices.

L x LP230L



Lever LP230L

Cast aluminum 3/4" (19mm) depth escutcheon. #06 lever is standard. #03 lever is optional.

STANDARD LEVER

#06 (Standard)



OPTIONAL LEVERS

#03



#07



#12



#17



Handed Lever

VON DUPRIN® 94/95 **INPACT™** Concealed Vertical Rod Devices

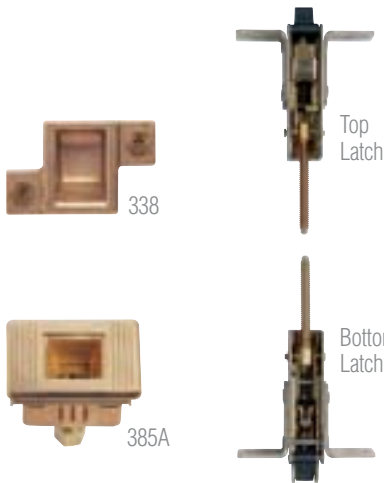

DIMENSIONS:

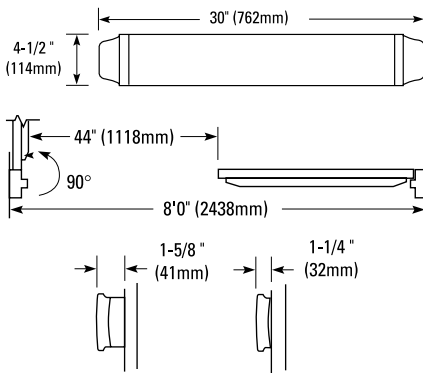

Clear Width - meets 44" clear width requirements on corridor doors serving areas occupied or used by bed patients. Application uses a 2" (51mm) face frame and 1-11/16" (43mm) swing clear hinges.

STANDARD TRIM	NUMBER
Lever	LP373L*
OPTIONAL TRIMS	
Dummy Pull	550DT
Thumbturn	376T
Lever	LP230L
STANDARD LEVER	
	06
OPTIONAL LEVERS	
	03, 07, 12, 17

*Blank Escutcheon "BE" available. Example: LP373L-BE

DEVICE OPTIONS

Electric latch retraction	pg. 13
Latchbolt monitoring	pg. 13
Less bottom rod	pg. 13

FIRE-RATED AND PANIC CONCEALED VERTICAL ROD DEVICES

Models	9447 and 9547
Fire-Rated Models	9447-F and 9547-F
Device Handling	Non-handed
Functions	See Trim Selection Chart on page 12
Finishes	See Finishes Chart on page 14
Styles	Smooth 94 Series and Grooved 95 Series
Pushpad	Extruded anodized aluminum
Endcaps	Die-cast aluminum, sloped design
Strikes	Standard 338 and 385A provided.
Latchbolt	5/8" (16mm) throw. Top and bottom latching are standard. (Optional LBR is available, with no need for floor strike.)
Deadlocking Latchbolt	Standard
Dogging Feature	Hex key dogging
Door Sizes	2'10" (864mm) to 4'0" (1219mm) width 10'0" (3048mm) maximum height 1-3/4" (44mm) thickness
Device Height	4-1/2" (114mm)
Device Length	30" (762mm)
Device Center Line to Finished Floor	39-5/8" (1006mm)
Projection	1-5/8" (41mm) neutral 1-1/4" (32mm) depressed
Fasteners	Included for surface mounting to recessed door prep and through bolting to trim.
ANSI Grade	Certified to ANSI/BHMA A156.3 Grade 1. Tested at one million cycles.
Concealed Vertical Rods	Two-piece adjustable rods, door 6'8" (2032mm) to 8'4" (2540mm). Can be adjusted by removing the latchside endcap.
Optional Extension Rod	Adjustable for doors 8'4" (2540mm) to 10'0" (3048mm).

575



DIMENSIONS:

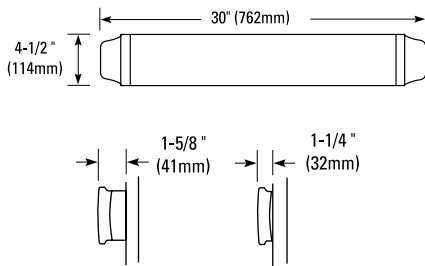

STANDARD TRIM	NUMBER
Lever	LP373L*
OPTIONAL TRIMS	
Dummy Pull	550DT
Lever	LP230L
STANDARD LEVER	
	06
OPTIONAL LEVERS	
	03, 07, 12, 17

*Blank Escutcheon "BE" available. Example: LP373L-BE

DEVICE OPTIONS

Electric latch retraction	pg. 13
Request to exit	pg. 13
Latchbolt monitoring	pg. 13

FIRE-RATED AND PANIC MORTISE LOCK DEVICES

Models	9475 and 9575
Fire-Rated Models	9475-F and 9575-F
Device Handing	Non-handed
Functions	See Trim Selection Chart on page 12
Finishes	See Finishes Chart on page 14
Styles	Smooth 94 Series and Grooved 95 Series
Pushpad	Extruded anodized aluminum
Endcaps	Die-cast aluminum, sloped design
Strike	Standard 575
Latchbolt	3/4" anti-friction, field reversible
Deadlocking Latchbolt	Standard
Mortise Lock Center Line to Finished Floor	48-1/8" (1222mm)
Dogging Feature	Hex key dogging
Door Sizes	2'10" (864mm) to 4'0" (1219mm) width 10'0" (3048mm) maximum height 1-3/4" (44mm) thickness
Device Height	4-1/2" (114mm)
Device Length	30" (762mm)
Device Center Line to Finished Floor	39-5/8" (1006mm)
Projection	1-5/8" (41mm) neutral 1-1/4" (32mm) depressed
Fasteners	Included for surface mounting to recessed door prep and through bolting to trim.
ANSI Grade	Certified to ANSI/BHMA A156.3 Grade 1. Tested at one million cycles.

VON DUPRIN® *INPACT™* Trim Selection

94/95 TRIM SELECTION

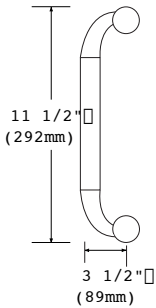
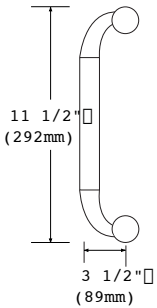
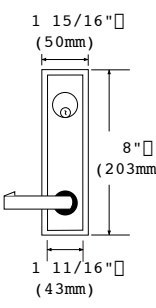
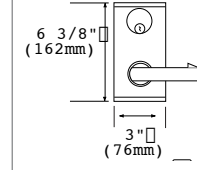
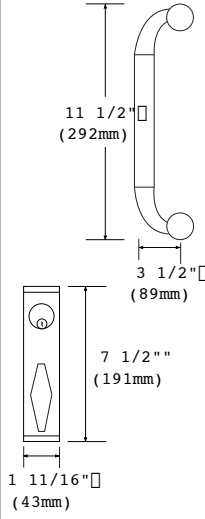
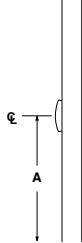
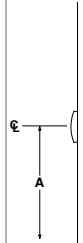
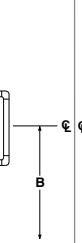
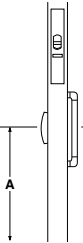
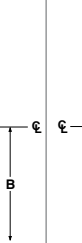
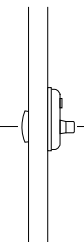
Function		01 Exit Only	02 Pull When Dogged	03 Key Retracts Latchbolt	08 Key Locks Lever	08 Key Locks Lever	11 Key Locks Thumbturn
Trim Number and Dimensions			550DT 	550DT x Cylinder 	LP373L 	LP230L 	550DTx376T 
Device/Trim Center Line To Finished Floor							
Projection			2-5/8"	2-5/8"	3-1/8"	2-5/8"	1-13/16" / 2-5/8"
Concealed Vertical Rod	Panic	9447EO 9547EO	9447DT 9547DT	— —	9447L 9547L	9447L 9547L	9447TL 9547TL
	Fire	9447EO-F 9547EO-F	— —	— —	9447L-F 9547L-F	9447L-F 9547L-F	9447TL-F 9547TL-F
	Ctr. Line	39-5/8"	A 39-5/8" B 39-5/8"	— —	A 39-5/8" B 39-5/8"	A 39-5/8" B 38-5/8"	A 39-5/8" B 53-1/2"
Mortise Lock	Panic	9475EO 9575EO	9475DT 9575DT	9475NL 9575NL	9475L 9575L	9475L 9575L	— —
	Fire	9475EO-F 9575EO-F	— —	9475NL-F 9575NL-F	9475L-F 9575L-F	9475L-F 9575L-F	— —
	Ctr. Line	39-5/8"	A 39-5/8" B 39-5/8"	A 39-5/8" B 39-5/8"	A 39-5/8" B 39-5/8"	A 39-5/8" B 38-5/8"	— —
Cylinder Type Required	Vert. Rod Dev.	—	—	—	Mortise*	Mortise*	Mortise*
	Mortise Dev.	—	—	Mortise*	Mortise*	Mortise*	—

*See page 13 for cylinder information.

Electric Latch Retraction

The EL feature allows for the remote latch retraction of exit devices. A control station operator can flip a switch to retract the latchbolt and immediately change an exit door to push/pull operation. A powerful, continuous-duty solenoid retracts the latchbolt either for momentary unlocking or for extended periods of time. The EL feature is an alternative to manual dogging. EL devices are also useful with automatic door operators, and may be applied to fire-rated devices when under the control of an **automatic fire alarm system**. UL approved for Class II circuit applications. This feature does not include the power transfer from door to frame, nor the power supply or control operator.

Solenoid Specifications: Continuous-Duty 24 VDC. Current Inrush 16 Amps. Current Holding (450 milliamps) 0.5 Amps. To Order: Specify prefix EL.

Latchbolt Monitoring

The latchbolt monitor or (LX) feature gives an electronic signal when someone enters an opening from the trim side of the door. The device can then be connected to a security console or may be used as a single door alarm when used with a horn and power supply. The (LX) switch is located inside the device's pushpad on a concealed vertical rod device. For a mortise device, the switch is located inside the mortise lock.

Electrical Ratings: 0.5 Amp., 24 VDC. To Order: Specify prefix LX.

INPACT Accessories

Cylinders are not furnished with device or trim and must be specified when ordering. Mortise lock exit devices and the LP373L, 376T and LP230L use mortise-type cylinders.



Mortise - 3215 (Schlage B502-191 cam)

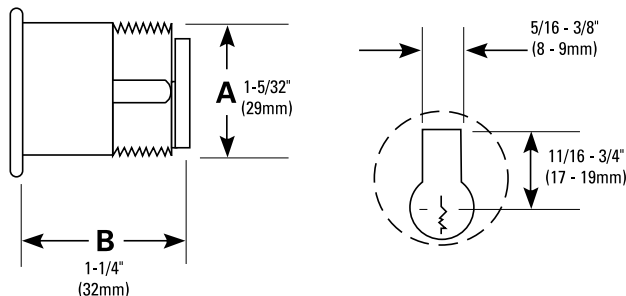

Less Bottom Rod

The Less Bottom Rod (LBR) option is available for concealed vertical rod devices. In lieu of a bottom rod and latch, a spring-loaded auxiliary bolt is installed in the lower door edge. When exposed to heat, during a fire, the auxiliary latch releases, keeping the doors in alignment and closed. UL listed for 3 hours on double egress doors and for 90 minutes on doors swinging in the same direction. The LBR option is not recommended for exterior door openings or where security is critical.

Request to Exit

The pushpad monitor or (RX) feature gives an electronic signal when someone exits an opening from the device side of the door. The device can then be connected to a security console or may be used as a single door alarm when used with a horn and power supply. The (RX) feature is available only on mortise devices using the (NL) function. The (RX) switch is located inside the mortise device's pushpad.

Electrical Ratings: 0.5 Amp., 24 VDC. To Order: Specify prefix RX.

VON DUPRIN® *INPACT™* Specifications

UL LISTED—FIRE EXIT HARDWARE LABEL/OPENING SIZE

Exit Device	Single Door	Double Doors	
		Same Direction	Double Egress
9475-F	3 Hour	—	—
9575-F	4' x 10'	—	—
9447-F	—	90 Minute	3 Hour
9547-F	—	8' x 10'	8' x 10'
9447LBR-F	—	90 Minute	3 Hour
9547LBR-F	—	8' x 10'	8' x 10'

Consult your door manufacturer for maximum listed door height.



FINISHES	US NUMBER	BHMA NUMBER
Brass, Polished	US3	605
Brass, Satin	US4	606
Bronze, Satin	US10	612
Chrome, Polished	US26	625
Chrome, Satin	US26D	626
Aluminum, Anodized	US28	628
Duranodic Dark Bronze	313	710

NOMENCLATURE

		EL	94	47	L	BE	F	LBR	US3	RHR
EL	Electric Latch Retraction									
LX	Latchbolt Monitoring									
RX	Request to Exit Switch									
94	Series 94									
95	Series 95									
47	Concealed Vertical Rod (up to 10'0")									
75	Mortise Lock Device									
DT	Dummy Trim									
EO	Exit Only									
L	Lever Trim									
TL	Thumbturn									
BE	Blank Escutcheon									
None	Panic Exit Hardware									
F	Fire Exit Hardware									
None	Top and Bottom Rod									
LBR	Less Bottom Rod									
Finish	See Finish Chart									
Lever Handing	Specify Right-Hand – RHR or Left-Hand – LHR									

How-To-Order Information



SINGLE DOOR: 9475 AND 9575

1. Specify model and trim selection.
Examples: 9475L-F (Fire exit device, mortise lock, smooth pushpad, lever trim)
9575DT (Panic device, mortise lock, grooved pushpad, dummy trim)
2. Specify finish (see Finishes Chart).
3. Handing required on lever trims. Specify RHR or LHR.
4. Options as desired.
Example: EL prefix (Electric Latch Retraction) EL9475L-F x US26D x RHR

DOUBLE DOOR: 9447 AND 9547

1. Specify model and trim selection.
Examples: 9447L-F (Fire exit device, concealed rod, smooth pushpad, lever trim)
9547DT (Panic device, concealed rod, grooved pushpad, dummy trim)
2. Specify finish (see Finishes Chart).
3. Handing required on lever trims. Specify RHR or LHR.
4. Options as desired.
Examples: LBR suffix (Less Bottom Rod) 9447-F-LBR x US3 x RHR
EL prefix (Electric Latch Retraction) EL9547L-F x US26D x RHR

INPACT™ 94 AND 95 Series Exit Devices



Visit Von Duprin on the web
www.vonduprin.com



VON DUPRIN

2720 Tobey Drive,
Indianapolis, IN 46219
317-613-8944 phone
317-613-8302 fax
www.vonduprin.com
www.irsecurityandsafety.com

An **IR Ingersoll-Rand** business