

Two styles — mechanically and dimensionally identical, for a wider selection of appearance options.

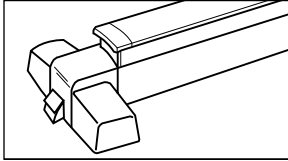

CX98 Series features a smooth mechanism care.

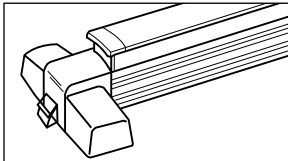

CX99 Series features a grooved mechanism care.

Introduction

Proper selection and application, in addition to safety, are major concerns to all responsible manufacturers. Chexit Controlled Exit Device is a critical part of an access system, and will provide safe and reliable service when properly applied and maintained. It is the policy of Von Duprin, Inc., to design and manufacture to a high standard of quality and reliability in accordance with accepted U.S. domestic and international standards. UL listed “Controlled Exit Panic Device,” for use on Panic Exit or Fire Exit hardware applications and tested in accordance to ANSI A156.3, 2001, Grade I. Chexit meets all requirements for NFPA101, Special Locking Arrangement.

It is intended that the information included in this publication, when properly used, will provide clear and reliable guidelines to the proper general selection and application. However, the scope of the information is necessarily limited.

Unusual operating conditions and environments, and other external influence can affect the proper application of the products represented. Modifications of these products will also affect UL listings. It is recommended whenever an unusual application condition exists, or when any modification of a product is considered, that our engineers review the application.

Von Duprin, Inc. application engineering services are available to help ensure proper selection or to review any areas where users of Von Duprin products may have questions.

Index

Introduction	2	Cover Plate Kits	13
Chexit™ Features	3	Glass Bead Kit	13
Exit Hardware		CD Cylinder Dogging	12
Rim Device	4	Electric Mortise Lock	12
Mortise Lock Device	5	Electrical Power Transfer	12
Concealed Vertical Rod Device	6	Mini Power Boosters	12
Wood Door Concealed Vertical Rod Device	7	Applications and Wiring	14-15
Trims	8-9	Additional Information	
Strikes	10-11	Electrical Specifications	16
Strike Application/Minimum Stile	10	Finishes	16
Accessories		Fire Label Ratings/Applications	16
Cylinders	13	Handing of Doors	16
Dummy Push Bar	13	How-To-Order	17
Optional levers	9	Nomenclature	18
		Typical Specification	17

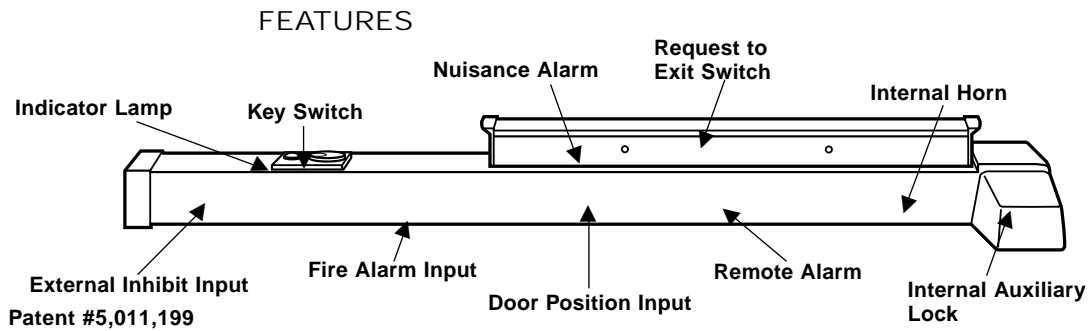

User Definable Rearm Time — The Rearm Time is the amount of time after the device is activated (via key switch or external inhibit) before it arms. It is designed to give someone time to pass through the door before arming occurs. Timing can be changed by the user for any time between 2 and 28 seconds in two second increments.

There is also an infinite rearm setting that requires the use of an external door position switch. In this setting the door remains in the rearm mode until the door is closed. This can be useful on jet way doors in an airport.

Factory Definable Delay Time — Most jurisdictions allow 15 seconds of delay before allowing egress. In those cases where 15 seconds is not appropriate, Von Duprin can set the Chexit for any delay time between 0 and 60 seconds on 2 second increments. For delays greater than 15 seconds a letter from the local authority is required.

Request to Exit Switch is built into the device to detect when someone attempts to exit. Applying less than 15 pounds to the push pad when the device is armed will cause this switch to start an irreversible alarm cycle.

Nuisance Alarm — When a Chexit is located in a public area, it can be desirable to limit false alarms. If the Nuisance Audible and Nuisance Delay options are set to off, the device will go into alarm as soon as the push pad is touched (when armed). Turning the Nuisance Delay on will require the push pad to be pressed for 2 seconds before the Chexit goes into alarm. If the Nuisance Audible and Nuisance Delay are both on, the alarm will sound as soon as the push pad is pressed, but the alarm sequence will stop unless the push pad is held for 2 seconds or more.

Remote Alarm — A set of relay contacts (rated 1 ampere, 24 VDC) are provided to give external alarm indication. These contacts close when the device is in an irreversible alarm condition (If Nuisance Audible is enabled, they will not close until the push pad has been held for more than 2 seconds). These contacts can be used to drive a horn, lamp, or other indicative device.

Key Switch — The Key Switch provides the means to arm, disarm, or reset the Chexit. The key can be removed in either the Arm or Disarm position. In cases where the key switch is not used for controlling the device, a blank cylinder can be used.

Indicator Lamp — The status of the Chexit can be determined by the Indicator Lamp. A masked bezel design provides wide angle viewing in any lighting condition. When the lamp is off, this indicates the device is disarmed and is functioning as a normal exit device (no delay). A continuously on lamp indicates the device has just been armed and as soon as the selectable rearm timer expires, the device will arm. A slow flashing lamp indicates the device is armed. A fast flashing indicator lamp indicates the device is in alarm.

Internal Horn — Whenever the device is in alarm or the push pad is pressed the internal horn will sound. The volume level of this horn exceeds 85 db at 6 feet. The user can select whether or not this horn sounds during a fire alarm condition.

Door Position Input — An external door position switch can be connected to the Chexit. Doing this gives added security to the opening and is recommended. If a door position switch is used, it will cause the alarm to sound if the door is not closed when the device is armed; it will sound the alarm if the door is forced open while the device is armed; it will provide anti-pass-back by cutting short the rearm time.

External Inhibit Input — This optional input is provided to allow remote override of the Chexit in the armed condition. It also allows remote reset of the Chexit in an alarmed condition. Typical device connections include card readers, wall-mounted key switches, or a remote security console. This input is controlled with a Normally closed switch (open = disarmed).

Fire Alarm Input — This input disables the Chexit immediately upon a fire alarm. The building's fire alarm system should provide normally closed contacts which open on alarm.

Internal Auxiliary Lock — The Auxiliary Lock is engaged when the Chexit is armed. The locking mechanism is specifically designed to hold securely even when the exit device is struck with forceful blows. The mechanism will also release upon command irregardless of the force applied to the push pad. An override spring prevents damage to internal components when more than 75 pounds of force are exerted on the push pad.

VON DUPRIN[®]

Chexit[™] Rim Device

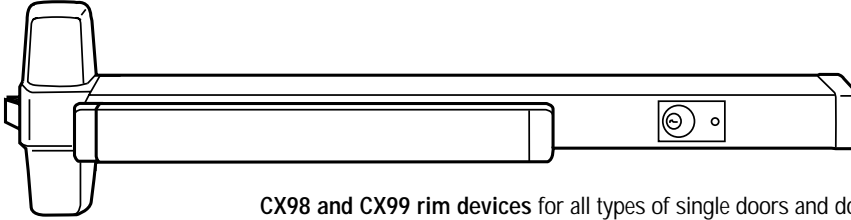

Standard 1-1/4" (32mm) mortise cylinder must be ordered separately.

CX98 and CX99 rim devices for all types of single doors and double doors with mullion, UL listed for accident hazard installations. Covers stock hollow metal doors with 86 or 161 cutouts.

CX98-F and CX99-F fire exit rim devices for all types of 4' x 8' (1219mm x 2438mm) single doors or 8' x 8' (2438mm x 2438mm) double doors with 9954 mullion, UL listed for A, B, C, D or E fire-labeled installations.

Features

- Nonhanded
- Field sizeable
- 3/4" (19mm) throw, latch bolt
- Latch bolt dead locking
- Eight popular finishes

Dimensions

Touchbar height to finished floor	39-13/16" (1011mm) at center
Touchbar projection — neutral	3-13/16" (97mm)
depressed	3-1/16" (78mm)
Center case	8" x 2-1/4" x 2-3/4" (203mm x 57mm x 70mm)
Device length — Short 3' (914mm)	2'10" to 3' (864mm to 914mm) door size
Long 4" (1219mm)	3'4" to 4' (1016mm to 1219mm) door size



Strikes and Fasteners

Device is furnished with standard 299 or 299F strikes in dull black finish, 499F is required on double fire doors. For optional strikes, finishes, applications, dimensions and minimum door stile information refer to page 10.

A combination of fasteners are included for surface mounting and through bolting to trim on 1-3/4" (44mm) and 2-1/4" (57mm) thick doors.



Device Option

Cylinder dogging, page 13

For How-To-Order Information on all devices, see page 17.

For electrical specifications, see page 16.

For power supply and power transfer information, see page 12.

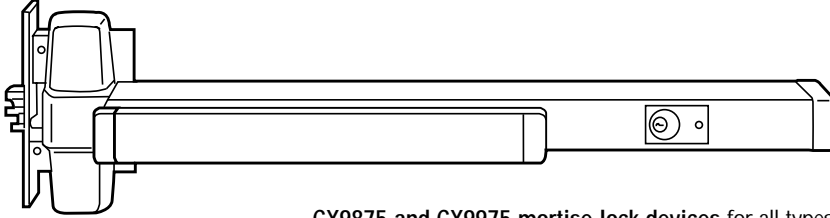

Standard 1-1/4" (32mm) mortise cylinder must be ordered separately.

When using Chexit mortise lock, the outside trim will operate the door without affecting the device in an armed condition, if a door position switch is not used.

The 7500 Mortise lock is equipped with a 3/4" (19mm) anti-friction latch bolt which is field reversible without removing the lock from the door. It has a nonhanded auxiliary bolt for deadlocking, and a faceplate which has an adjustable bevel. Field selection of functions are furnished standard. TP, K or L function may be field selected by adjusting a set screw. **Electric locking and unlocking**, and signal switch options are available, refer to page 11.

CX9875 and CX9975 mortise lock devices for all types of single doors or double doors, UL listed for accident hazard installations. Fits stock hollow metal doors with 86 cutout, and door stiles as narrow as 4-3/4" (121mm).

CX9875-F and CX9975-F fire exit mortise lock devices for all types of 4' x 10' (1219mm x 3048mm) single doors or 8' x 8' (2438mm x 2438mm) double door installations, UL listed for A, B, C, D or E fire-labeled installations. Fits door stiles as narrow as 4-3/4" (121mm).

Features

- Nonhanded
- Full reversible mortise lock
- Field sizeable
- 3/4" (19mm) throw, anti-friction latch bolt
- Latch bolt deadlocking
- Eight popular finishes

Dimensions

Touchbar height to finished floor	39-5/8" (1006mm) at center
Latch bolt height to finished floor	40-3/32" (1018mm) at center
Touchbar projection —	
neutral	3-13/16" (97mm)
depressed	3-1/16" (78mm)
Center case	8" x 2-1/4" x 2-3/4" (203mm x 57mm x 70mm)
Device length — Short 3' (914mm)	2'10" to 3' (864mm to 914mm) door size
Long 4" (1219mm)	3'4" to 4' (1016mm to 1219mm) door size
Lock case	4-5/8" x 5-3/4" x 1-1/16" (118mm x 146mm x 27mm)
Faceplate	1-1/4" x 8" x 7/32" (32mm x 203mm x 6mm)
Cylinder backset	2-3/4" (70mm)



575



575-2



576A



576B

Strikes and Fasteners

Device is furnished with standard 575 strike in dull black finish. For optional strikes, finishes and dimensions refer to page 10.

575 Strike — for use on 1-3/4" (44mm) or 2-1/4" (57mm) single doors and 2-1/4" (57mm) double doors with coordinator.

575-2 Strike — for use on 1-3/4" (44mm) double doors with coordinator.

576A Strike — open back strike for 1-3/4" (44mm) double doors without coordinator.

576B Strike — open back strike for 2-1/4" (57mm) double doors without coordinator.

A combination of fasteners are included for surface mounting and through bolting to trim on 1-3/4" (44mm) and 2-1/4" (57mm) thick doors.

Device Option

Cylinder dogging, page 13

For How-To-Order Information on all devices, see page 17.

For electrical specifications, see page 16.

For power supply and power transfer information, see page 12.

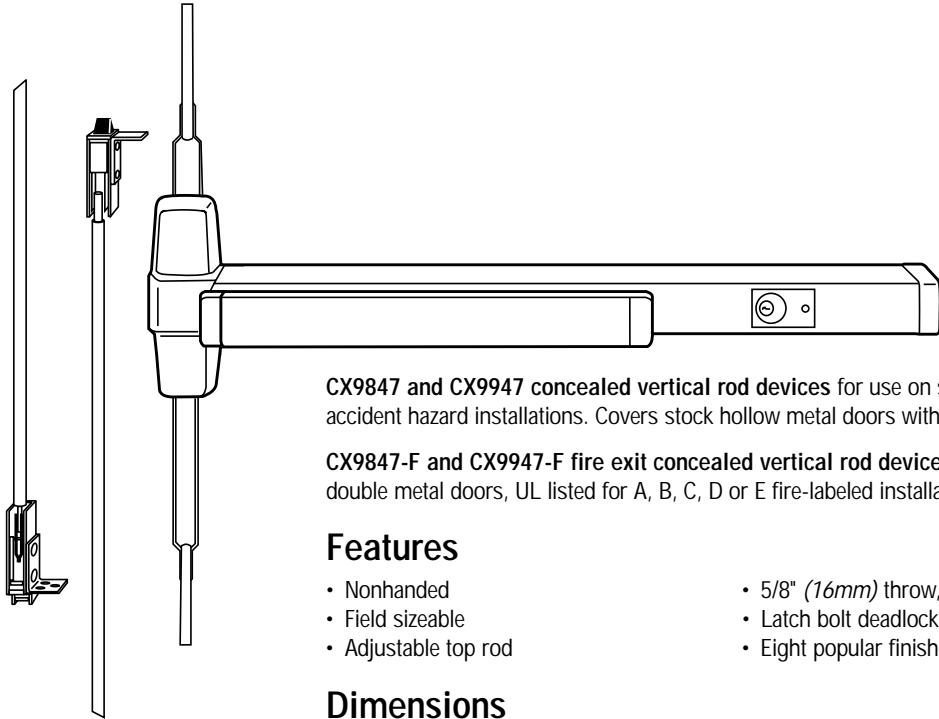

Standard 1-1/4" (32mm) mortise cylinder must be ordered separately.

CX9847 and CX9947 concealed vertical rod devices for use on single or double metal doors, UL listed for accident hazard installations. Covers stock hollow metal doors with 86 or 161 cutouts.

CX9847-F and CX9947-F fire exit concealed vertical rod devices for use on 8' x 8' (2438mm x 2438mm) double metal doors, UL listed for A, B, C, D or E fire-labeled installations.

Features

- Nonhanded
- Field sizeable
- Adjustable top rod
- 5/8" (16mm) throw, latch bolt
- Latch bolt deadlocking
- Eight popular finishes

Dimensions

Touchbar height to finished floor	39-5/8" (1006mm) at center
Touchbar projection — neutral	3-13/16" (97mm)
depressed	3-1/16" (78mm)
Center case	8" x 2-1/4" x 2-3/4" (203mm x 57mm x 70mm)
Device length — Short 3' (914mm)	2'10" to 3' (864mm to 914mm) door size
Long 4" (1219mm)	3'4" to 4' (1016mm to 1219mm) door size
Vertical rods — round	Two piece adjustable top rod

Surface mounted vertical rod devices are available, but not recommended unless used with rod and latch guards and monitor strike, consult factory.

Strikes and Fasteners

Device is furnished with standard 338 and 385A strikes. For optional strikes, finishes, applications, dimensions and minimum door stile information refer to page 10.

A combination of fasteners are included for surface mounting and through bolting to trim on 1-3/4" (44mm) and 2-1/4" (57mm) thick doors.



338



385A

Device Option

Cylinder dogging, page 13

For How-To-Order Information on all devices, see page 17.
 For electrical specifications, see page 16.
 For power supply and power transfer information, see page 12.

Chexit™ Wood Door Concealed Vertical Rod Device

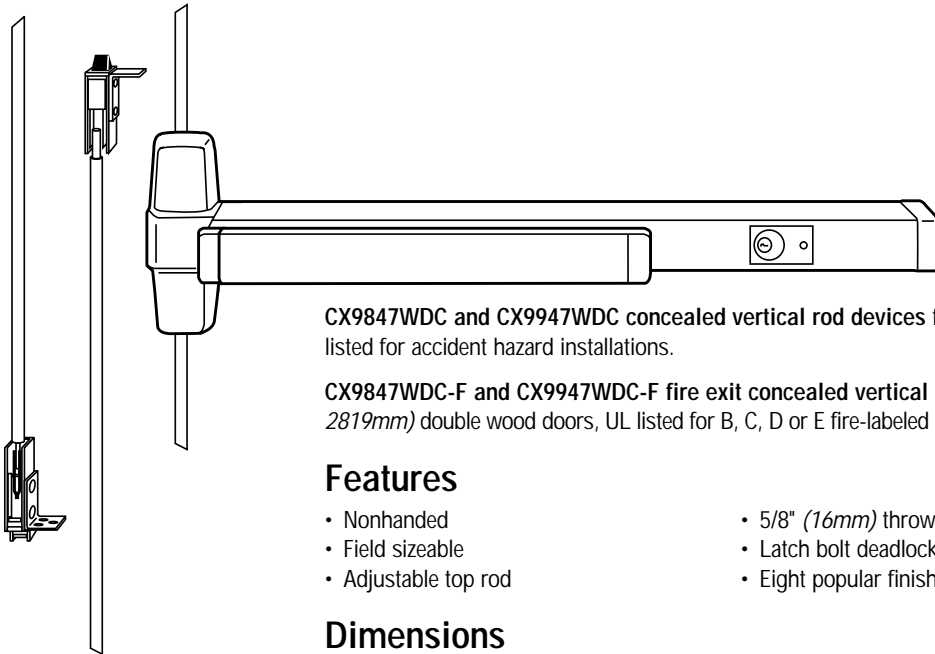

Standard 1-1/4" (32mm) mortise cylinder must be ordered separately.

CX9847WDC and CX9947WDC concealed vertical rod devices for use on single or double wood doors, UL listed for accident hazard installations.

CX9847WDC-F and CX9947WDC-F fire exit concealed vertical rod devices for use on 8' x 9'3" (2438mm x 2819mm) double wood doors, UL listed for B, C, D or E fire-labeled installations. For use on approved doors only.

Features

- Nonhanded
- Field sizeable
- Adjustable top rod
- 5/8" (16mm) throw, latch bolt
- Latch bolt deadlocking
- Eight popular finishes

Dimensions

Touchbar height to finished floor	39-5/8" (1006mm) at center
Touchbar projection — neutral	3-13/16" (97mm)
depressed	3-1/16" (78mm)
Center case	8" x 2-1/4" x 2-3/4" (203mm x 57mm x 70mm)
Device length — Short 3' (914mm)	2'10" to 3' (864mm to 914mm) door size
Long 4" (1219mm)	3'4" to 4' (1016mm to 1219mm) door size
Vertical rods — round	Two piece adjustable top rod



575



575-2



576A



576B

Strikes and Fasteners

Device is furnished with standard 338 and 385A strikes. For optional strikes, finishes, applications, dimensions and minimum door stile information refer to page 10.

A combination of fasteners are included for surface mounting and through bolting to trim on 1-3/4" (44mm) and 2-1/4" (57mm) thick doors.

Device Option

Cylinder dogging, page 13

Scalp Plate

Device is furnished standard with an 8" (203mm) long scalp plate for easy access to rods.

For How-To-Order Information on all devices, see page 17.





For electrical specifications, see page 16.

For power supply and power transfer information, see page 12.

VON DUPRIN

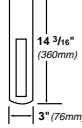
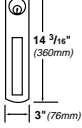
Trim Selection

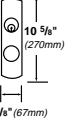
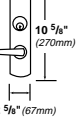
Trim operation — rim and vertical rod application, trim **will not** function when Chexit is armed. Mortise application, trim **will** function when Chexit is armed.

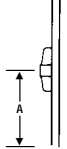
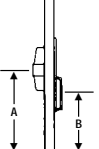
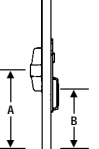
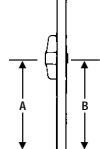
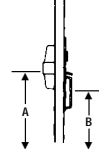
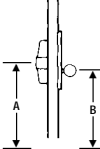
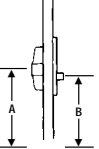
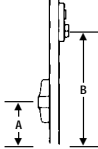
Function	01 Exit Only	02 Pull When Dogged	03 Key Retracts Latch Bolt	03 Key Retracts Latch Bolt	05 Key Locks Thumbpiece	08 Key Locks Knob	08 Key Locks Lever	11/12 Key Locks Thumbturn	
Trim Number and Dimensions		990DT 	990NL 	NL-OP 	990TP 	991K 	992L 	376T 376T-WDC 	
Device/Trim Center Line To Finished Floor									
Projection	—	2" (51mm)	2" (51mm)	—	2" (51mm)	3-3/4" (95mm)	2-3/4" (70mm)	1-3/4" (44mm)	
Rim	Panic	CX98EO CX99EO	CX98DT CX99DT	CX98NL CX99NL	CX98NL-OP CX99NL-OP	CX98TP CX99TP	CX98K CX99K	CX98L CX99L	—
	Fire▲	CX98EO-F CX99EO-F	—	CX98NL-F CX99NL-F	CX98NL-OP-F CX99NL-OP-F	CX98TP-F CX99TP-F	CX98K-F CX99K-F	CX98L-F CX99L-F	—
	Clr. Line	A 39-13/16" 1011mm	A 39-13/16" B 33-7/8" 1011mm 860mm	A 39-13/16" B 33-7/8" 1011mm 860mm	A 39-13/16" B 40-1/16" 1011mm 1018mm	A 39-13/16" B 33-7/8" 1011mm 860mm	A 39-13/16" B 37-3/16" 1011mm 945mm	A 39-13/16" B 37-3/16" 1011mm 945mm	—
Mortise Lock	Panic	CX9875EO CX9975EO	CX9875DT CX9975DT	CX9875NL CX9975NL	CX9875NL-OP CX9975NL-OP	CX9875TP CX9975TP	CX9875K CX9975K	CX9875L CX9975L	—
	Fire	CX9875EO-F CX9975EO-F	—	CX9875NL-F CX9975NL-F	CX9875NL-OP-F CX9975NL-OP-F	CX9875TP-F CX9975TP-F	CX9875K-F CX9975K-F	CX9875L-F CX9975L-F	—
	Clr. Line	A 39-5/8" 1006mm	A 39-5/8" B 33-11/16" 1006mm 856mm	A 39-5/8" B 33-11/16" 1006mm 856mm	A 39-5/8" B 39-7/8" 1006mm 1012mm	A 39-5/8" B 33-11/16" 1006mm 856mm	A 39-5/8" B 37" 1006mm 940mm	A 39-5/8" B 37" 1006mm 940mm	—
Concealed Vertical Lock	Panic	CX9847EO CX9947EO	CX9847DT CX9947DT	CX9847NL CX9947NL	CX9847NL-OP CX9947NL-OP	CX9847TP CX9947TP	CX9847K CX9947K	CX9847L CX9947L	CX9847TL CX9947TL
	Fire	CX9847EO-F CX9947EO-F	—	CX9847NL-F CX9947NL-F	CX9847NL-OP-F CX9947NL-OP-F	CX9847TP-F CX9947TP-F	CX9847K-F CX9947K-F	CX9847L-F CX9947L-F	CX9847TL-F CX9947TL-F
	Clr. Line	A 39-5/8" 1006mm	A 39-5/8" B 33-11/16" 1006mm 856mm	A 39-5/8" B 33-11/16" 1006mm 856mm	A 39-5/8" B 33-11/16" 1006mm 1012mm	A 39-5/8" B 39-7/8" 1006mm 856mm	A 39-5/8" B 33-11/16" 1006mm 940mm	A 39-5/8" B 37" 1006mm 940mm	A 39-5/8" B 37" 1006mm 940mm
Concealed Vertical Rod Wood Door	Panic	CX9847WDC-EO CX9947WDC-EO	CX9847WDC-DT CX9947WDC-DT	CX9847WDC-NL CX9947WDC-NL	CX9847WDC-NL-OP CX9947WDC-NL-OP	CX9847WDC-TP CX9947WDC-TP	CX9847WDC-K CX9947WDC-KK	CX9847WDC-NL CX9947WDC-NL	CX9847WDC-TL CX9947WDC-TL
	Fire	CX9847WDC-EO-F CX9947WDC-EO-F	—	CX9847WDC-NL-F CX9947WDC-NL-F	CX9847WDC-NL-OP-F CX9947WDC-NL-OP-F	CX9847WDC-TP-F CX9947WDC-TP-F	CX9847WDC-K-F CX9947WDC-K-F	CX9847WDC-NL-F CX9947WDC-NL-F	CX9847WDC-TL-F CX9947WDC-TL-F
	Clr. Line	A 39-5/8" 1006mm	A 39-5/8" B 33-11/16" 1006mm 856mm	A 39-5/8" B 33-11/16" 1006mm 856mm	A 39-5/8" B 39-7/8" 1006mm 1012mm	A 39-5/8" B 39-7/8" 1006mm 1012mm	A 39-5/8" B 33-11/16" 1006mm 856mm	A 39-5/8" B 37" 1006mm 940mm	A 39-5/8" B 59-1/2" 1006mm 1359mm
Sex bolt application quantity requirements ●	6	2	2	6	2	2	2	2	
Device Type	Rim	—	—	Rim	Mortise	Rim	Mortise	Rim	
Cylinder Type	—	—	—	—	—	—	—	—	
Required	Mortise	—	—	Mortise	Rim	Mortise	Rim	Mortise	
	Vert. Rod	—	—	Rim	—	—	—	—	

▲ Sex bolts application — when using 499-F strike, two additional 425 sex bolts are required. Wood door applications require two additional 825 sex bolts.

● Sex bolts are required on wood or composite fire door applications.

VON DUPRIN®

Trim Selection



990NL



991K

Standard Trim

Series 990

Heavy 10 gage (2.4mm) brass, bronze or stainless steel. DT, NL or TP functions

Series 991

Forged brass 3/4" (19mm) thick. Operational options — K, DT, NL or BE

Series 992

Forged brass 3/4" (19mm) thick. Operational options — L, DT, NL or BE



992L



370T

Series 370

Forged brass 7/8" (22mm) thick escutcheon.

Lever Design Options

To order: Use suffix lever number, example 9927L x 01.



#01



#02



#03



#06 (Std.)



#07



#12



#17

Operation Options — Lever and Knob

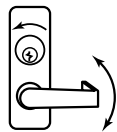

Standard operation, key locks and unlocks lever.

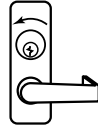

Night latch, key retracts latch bolt, lever is rigid. Use NL suffix, i.e., 992L-NL.

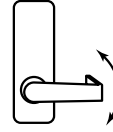

Blank escutcheon, lever always active. Use BE suffix, i.e., 992L-BE.

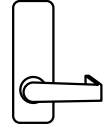

Dummy trim, lever rigid for pull operation. Use DT suffix, i.e., 992L-DT.



696



697

Optional Trim

Series 696

Narrow design 3/16" (5mm) thick brass, bronze or stainless steel. DT, NL or TP functions. Flat pull grip.

Series 697

Narrow design 3/16" (5mm) thick brass, bronze or stainless steel. DT, NL or TP functions. Round wire pull grip.

Series 390

Offset solid brass, bronze or stainless steel 3/4" (19mm) wire pulls, 7" (178mm) in length. Through bolts to Chexit.

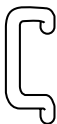

390

Strike Application/Minimum Stile Using Standard Trim

Device Type	Standard				Optional			
	Single door		Double door		Single door		Double door	
	Strike	Stile	Strike w/Mullion*	Stile	Strike	Stile	Strike w/Mullion*	Stile
					1409	3-13/16" (97mm)	299 x 5654	4-7/16" (113mm)
CX98	299	4-1/2" (114mm)	299 x 4954	4-7/8" (124mm)	1410	3-13-16" (97mm)	1408 x 5754	3-13/16" (97mm)
CX99					1606	4-1/16" (103mm)	1606 x 1654	4-7/16" (113mm)
CX98-F/CX99-F	299F	4-1/2" (114mm)	499F x 9954	4-7/8" (124mm)	—	—	—	—
			Strike	Stile	Strike	Stile	Strike	
CX9875							575-2	
CX9975	575	4-3/4" (121mm)	—	—	—	—	576A-576B	4-3/4" (121mm)
CX9875-F							575-2	
CX9975-F	575	4-3/4" (121mm)	—	—	—	—	576A-576B	4-3/4" (121mm)
	Strike		Application	Stile	Strike		Application	Stile
CX9847	338 (Top)		Single door	3-11/16" (94mm)	283 (Top)		Single door	3-11/16" (94mm)
CX9947	385A (Bottom)		Two Vertical		304L (Bottom)		Two Vertical	
CX9847WDC			Rod Devices	3-11/16" (94mm)			Rod Devices	3-11/16" (94mm)
CX9947WDC			Vertical Rod				Vertical Rod	
			w/Mortise				w/Mortise	
			Lock Device	4-3/4" (121mm)			Lock Device	4-3/4" (121mm)
CX9847-F	338 (Top)		Two Vertical	4-1/4" (108mm)	304L (Bottom)		Single door	4-1/4" (108mm)
CX9947-F	385A (Bottom)		Rod Devices				Rod Devices	
CX9847WDC-F								
CX9947WDC-F								

*Mullion information — refer to General and Auxiliary section.

Strikes for Rim Devices

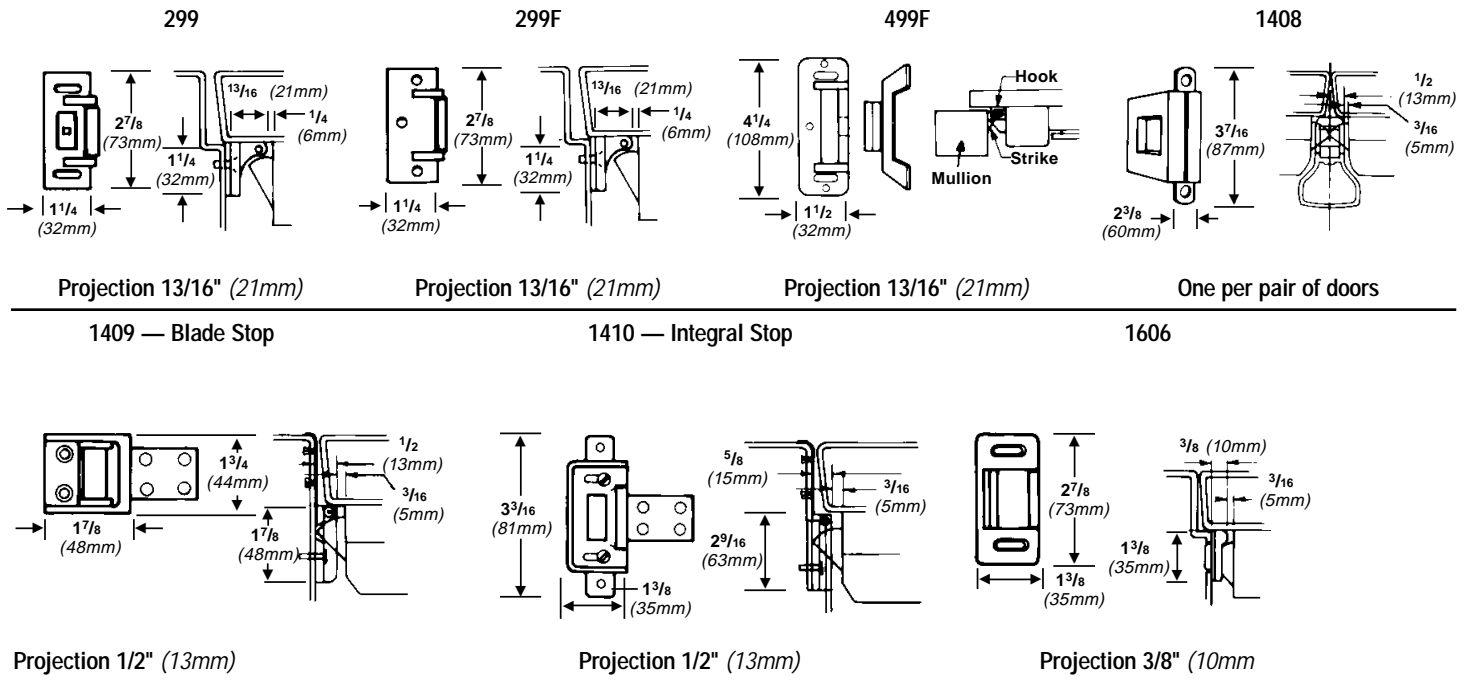

Strikes for Vertical Rod Devices

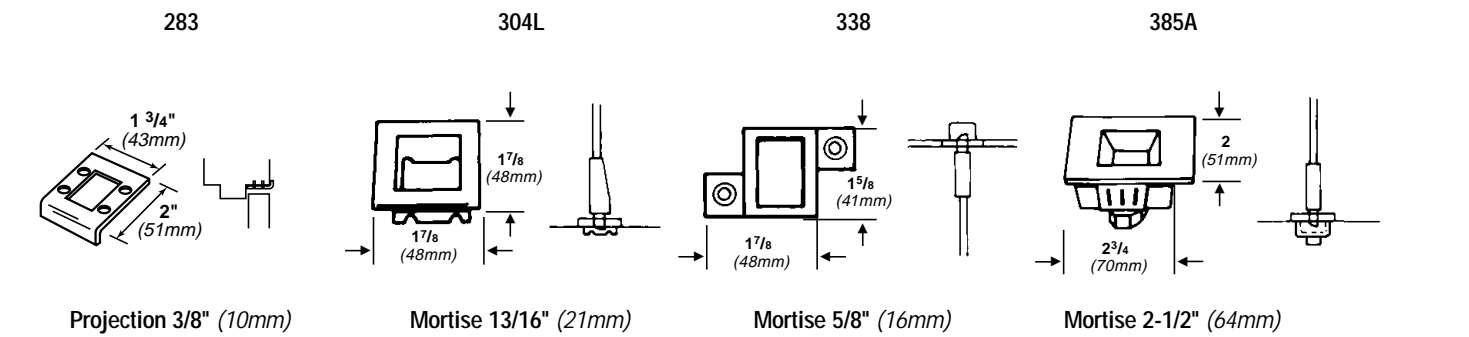

Strikes for Mortise Lock Devices

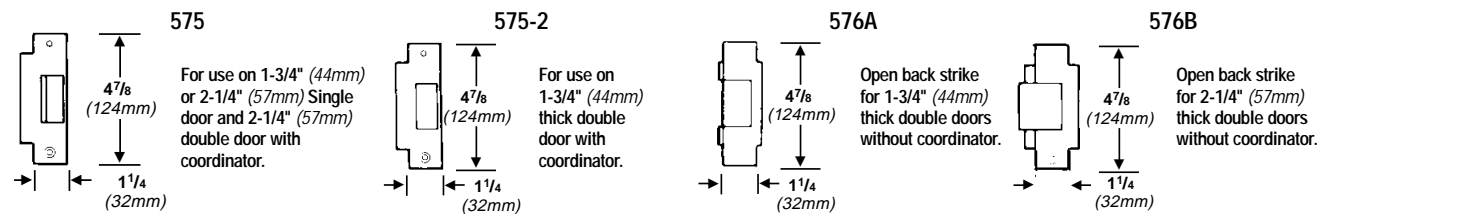

VON DUPRIN®

Accessories and Options

Electric Mortise Lock

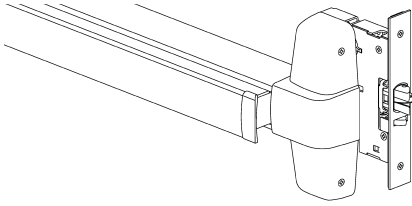

The electric mortise lock has all the versatility and advantages of the standard mortise lock, plus being electrically controllable by a remote switching device, and access control or automatic fire alarm system.

The E7500 controls the locking of the outside trim. When unlocked, the door remains latched, preserving the fire rating of the door and making it particularly useful where codes permit locking, but require unlocking during a fire emergency.

Standard Features

- Field reversible
- 24 VDC continuous duty solenoid
- Silent operation
- Signalling functions
- Corrosion resistant
- Tamper resistant
- Key mechanically retracts latchbolt

Optional Features

- Fail secure (unlocked when energized, locked when de-energized or during power failure). Furnished standard.
- Fail safe (unlocked when energized, locked when de-energized or during power failure). Specify with suffix "FS".
- 24 VAC (by adding SO option)
- 12 VDC or 12 VAC (with SO option)

Note: Some Fire codes will require "Fail Safe" (FS) operation for stairwell doors. Be sure to specify the correct operation for your application.

Electrical Power Transfer

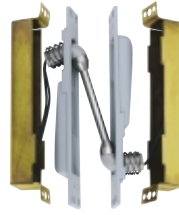

The EPT-10 provides a means to transfer power from the frame to the door stile in Chexit applications. It is used in installations with 4-1/2" x 4-1/2" (114mm x 114mm) butt hinges or 3/4" (19mm) offset pivots. The EPT-10 is reversible and allows a full (180°) door swing. When the door is closed, the unit is concealed for tamper resistance.

UL approved component for use with listed rim, mortise and vertical rod fire devices.

Dimensions:

Housing	9" x 1-7/16" x 1-1/2" (23mm x 37mm x 38mm)
Conductors	Ten 24 AWG UL Approved
Rating	10 Amps. at 24 VDC (Class 1 low voltage) (20 Amp. maximum surge)

Power Supplies



PS873 are UL approved power supplies and specifically designed to handle Chexit controlled exit device.

The PS873 is a 24 VDC, 2 Amp, regulated power supplies, 120 VAC input and can power up to four Chexits, but the rearm times must be staggered so that no two devices rearm at the same time.

Refer to the Door Control and Security Products Catalog for complete power supply information.

Specifications:

Housing	Surface Mount, No Lock 10" H x 12-1/2" W x 5" D (254mm x 323mm x 127mm)
Output	2.0 Amperes Continuous @ 24 VDC 16.0 Amperes Surge For 300 milliseconds
Inputs (Primary)	120 VAC — 102-132 VAC @ 1 Amp. 240 VAC — 204-264 VAC @ 1/2 Amp.

CD Cylinder Dogging

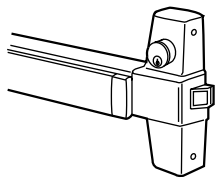

Cylinder dogging option is available to allow push/pull operation of Chexit, when disarmed and used in a heavy traffic area.

For typical electronic applications see pages 14-15.

Glass Bead Kit

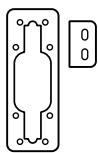

Glass bead conversion kits are available for use on doors with raised glass beads. Kit consists of 1/8" (3mm) shim sets.

Dummy Push Bar



The 330 grooved and 350 smooth dummy push bars are designed as a companion unit for all 98 or 99 devices. The touch bar is rigid or non-functioning. A push/pull operation can be accomplished by using 990DT or other pull trim.

Cover Plate Kit — 997 Kit



For rim device, kit contains inside and outside plates for hinge stile, an inside plate for the lock stile, and fasteners. Designed to cover most cutouts, 3-1/4" (83mm) x 9" (229mm).

Cylinders

Cylinders are not furnished with device or trim and must be specified when ordering. Rim, surface vertical rod, and concealed vertical rod exit devices use rim type cylinders. Mortise lock exit devices and series 370 controls use mortise type cylinders.

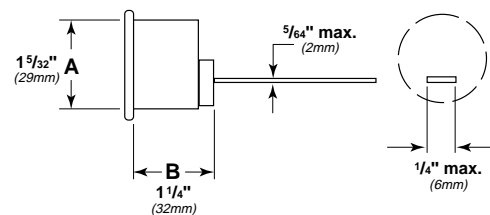
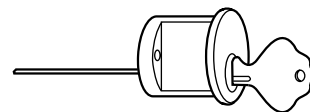
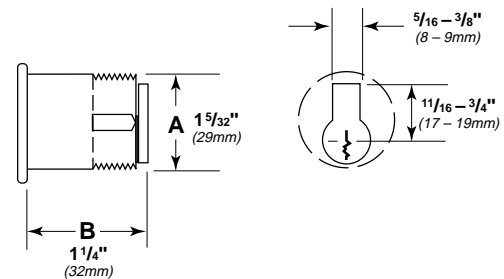
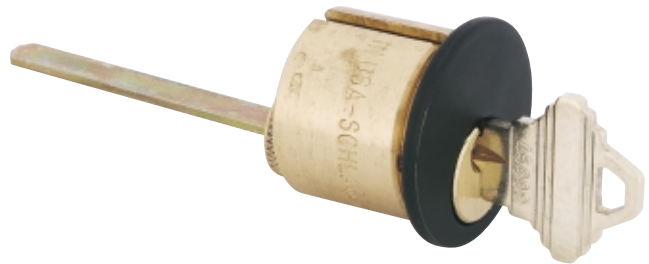

VON DUPRIN®

Applications and Wiring

Legend: +24 = 24 Volt DC; GND = Ground; SC = Signal Common; FA = Fire Alarm (input); DPS = Door Position Switch; EI = External Inhibit; (input) CM+ = Communication Line; CM- = Communication Line; NO = Normally Open External Alarm; C = Common External Alarm.

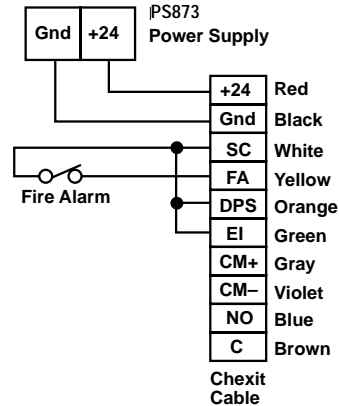
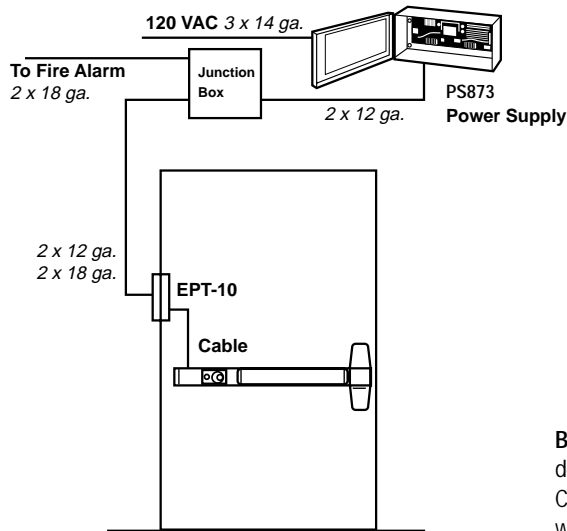

Basic Chexit single door application configuration consists of the Chexit device, power transfer and PS873 power supply. Using this setup, the Chexit will delay egress when armed and act as a normal exit device when turned off.

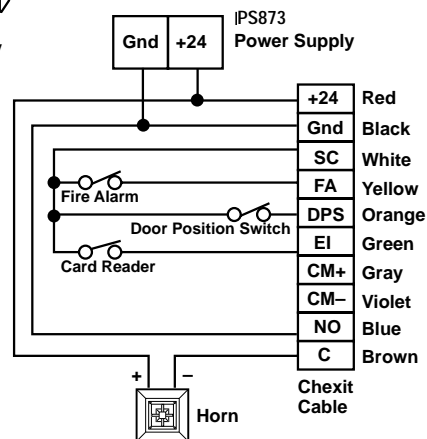
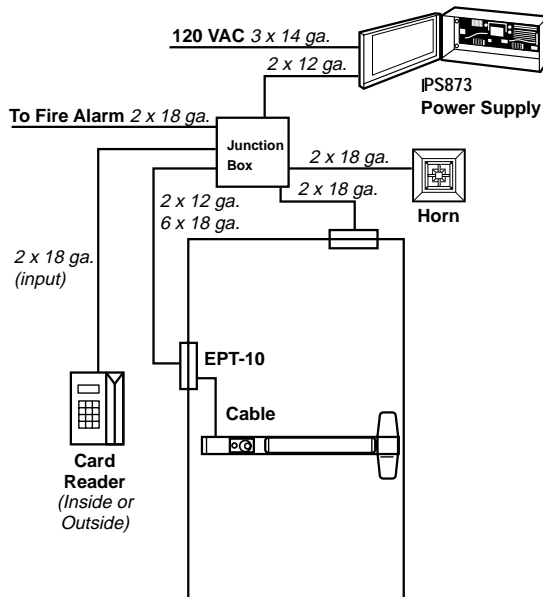

Chexit Single Door with Options — The Chexit is used as an access control device. The card reader allows access. Also shown in this application is an external horn and door position switch. The auxiliary horn is used for increased volume in remote locations. Using a door position switch gives added security to the opening in case the door is not reclosed.

With the Chexit disarmed, the opening functions as a normal exit device. If card readers are required on both sides of the door, the normally closed contacts of the readers should be wired in series.

VON DUPRIN®

Applications and Wiring

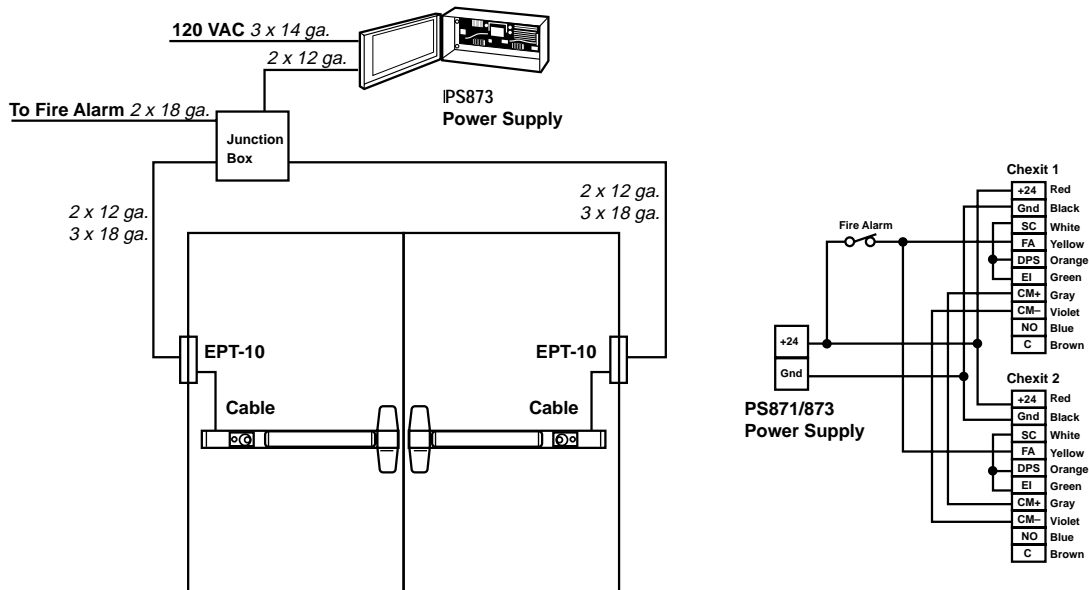

Basic Chexit Double Door application. When one Chexit is set into alarm, the other will also go into alarm. In an emergency situation both doors will disarm simultaneously.

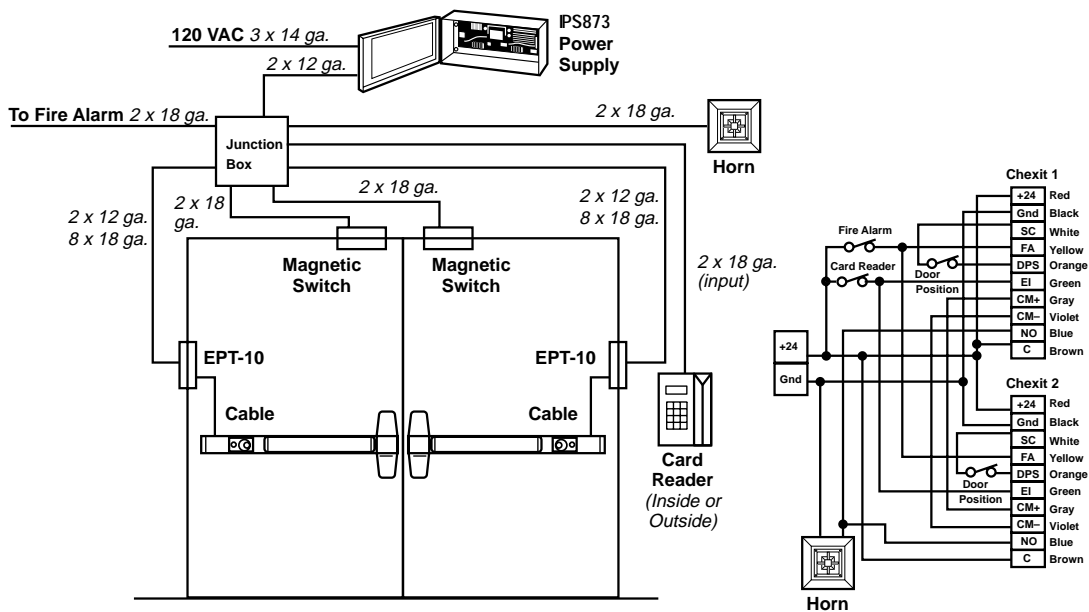

Double Door Chexit with Options shows the proper wiring for double door. The card reader will unlock both doors upon authorized access. For proper operation the rearm times are set two seconds apart.

VON DUPRIN®

Additional Information

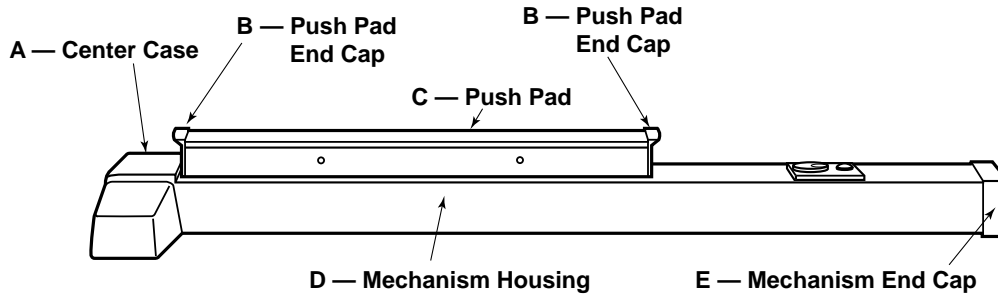

Finishes

Color	US Number	BHMA Number	A	B	C	D	E
Brass, Polished	US3	605	Brass	Plated	Brass	Buffed Anodized	Brass
Brass, Satin	US4	606	Brass	Plated	Brass	Anodized	Brass
Bronze, Satin	US10	612	Bronze	Anodized	Bronze	Anodized	Bronze
Chrome, Polished	US26	625	Stainless Steel	Plated	Stainless Steel	Buffed Anodized	Stainless Steel
Chrome, Satin	US26D	626	Stainless Steel	Plated	Stainless Steel	Anodized	Plated
Aluminum, Anodized	US28	628	Painted	Painted	Stainless Steel	Anodized	Painted
Stainless Steel, Satin [▲]	US32D	630	Stainless Steel	Stainless Steel	Stainless Steel	Anodized	Stainless Steel
Duranodic Dark Bronze	313AN	—	Painted	Painted	Walnut Grain Vinyl	Anodized	Painted

Push Pad Options — Black Vinyl, Brass, Bronze or Stainless Steel.

▲ Finish available on Series 98, only.

Fire Label Rating/Applications

Device UL Listing	Single Door		Double Door		
	4' x 8' (1219mm x 2438mm)	4' x 10' (1219mm x 3050mm)	Without Mullion Same Direction Vert./Vert.-Vert./Mrt.		Without Mullion Double Express
			With 9954 Mullion 4' x 8' (1219mm x 2438mm)	8' x 8' (2438mm x 2438mm)	8' x 8' (2438mm x 2438mm)
CX98-F/CX99-F	A Label	X	—	X	—
CX9875-F/CX9975-F	A Label	X	X	—	—
CX9847-F/CX9947-F	A Label [▲]	—	—	—	X
CX9847WDC-F/CX9947WDC-F	B Label [■]	—	—	—	—

▲ Special latches available for up to 10'0" (3048mm).

■ Approved for up to 9'3" (2819mm)

Handing of Doors

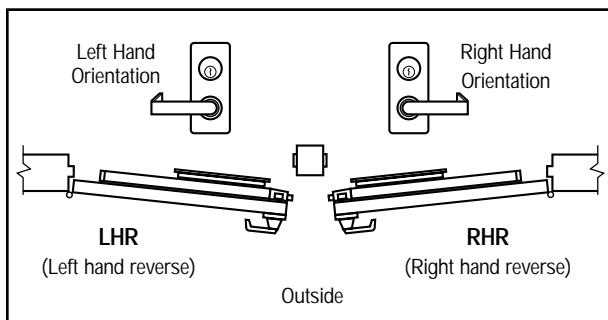

Electrical Specifications

Voltage — 24 VDC

Current — .4 Ampere with 300 millisecond 16 Ampere in-rush on arming

External Alarm Contact Rating — 24 VDC, 1 Ampere

Fire Alarm Input, External Inhibit Input, Door Position Input — setup for Normally Closed contacts.

Typical Specification

Basic System Design

Each Chexit controlled exit device is an emergency exit system consisting of a door or pair of doors equipped with Von Duprin CX99 exit device(s). The system has three modes of operation command:

- Emergency Save Exit Mode
- Secure Mode with Alarm and Conditional Release
- Authorized Exit Mode

Emergency Safe Exit Mode

Whenever the safety detector (smoke, fire, water flow, etc.) signals that an emergency condition is present to the Chexit, the device will unlock instantaneously, sound the horn and flash the lamp rapidly. The door(s) may be opened immediately in the usual manner by depressing the push pad. After authorized personnel reset the life safety detector system, the Chexit may be reset by actuation of the key cylinder located on the device. This will clear the alarm state and rearm the Chexit.

In the event of a power loss, the electronics become completely inactive, allowing the Chexit to operate as a normal exit device providing a means of egress from the building.

Secure Mode with Alarm & Conditional Release

The secure mode will operate whenever the doors are latched and the Chexit is activated to the armed state. This is identifiable by the slow flashing of the indicator lamp and the device push pad will appear to be locked. When the exit device on the door(s) is depressed the horn will sound along with a rapid flashing indicator lamp at the device. The push pad will remain in a locked state for the predetermined period of delay of 15 (or 30) seconds. This will allow time to intercept an unauthorized person who may be trying to exit. After the delay period, the push pad will retract the latchbolt permitting egress from the area. The horn sounding and rapid flashing light will continue until the Chexit is reset by authorized personnel at the key cylinder on the device.

Authorized Exit Mode

For authorized exit while the Chexit is armed, the door(s) may be released for a period of time, from 2 to 28 seconds without activating the alarm by turning key cylinder in counter clockwise or off position and resetting in clockwise position; system can remain disarmed in counter clockwise position. This mode is actuated by the key cylinder or an external access control input which allows the Chexit to operate as a normal exit device.

How-To-Order Information

1. Product description number.
2. Size 4' (1219mm) — for door sizes 3'4" to 4' (1016mm) to (1219mm).
Size 3' (914mm) — for door sizes 2'10" to 3' (864mm) to (914mm) are shipped standard.
3. Door thickness if other than standard 1-3/4" (45mm).
4. Finish, see page 16.
5. Handing, LHR or RHR. Required on "L" and "CD" function, only. See page 16.
6. "SNB" when using sex bolts.

Nomenclature

