

VON DUPRIN®

22 Series Exit Devices



IR Security & Safety
Proven Source. Proven Solutions.™

Finishes

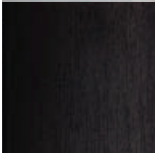
Color	US Number	BHMA Number
 Sprayed Aluminum	SP28	689
 Sprayed Dark Bronze	SP313	695

Index

	Introduction.....	1
Panic Exit Hardware	• Rim Devices	
	• 22 Rim Device	2
	• 22 Rim Device Trim.....	3
	• Surface Mounted Vertical Rod Devices	
	• 2227 Surface Mounted Vertical Rod Device.....	6
	• 2227 Surface Mounted Vertical Rod Device Trim.....	7
Fire Exit Hardware	• Fire Exit Rim Devices	
	• 22-F Fire Exit Rim Device	4
	• 22-F Fire Exit Rim Device Trim.....	5
	• Fire Exit Surface Mounted Vertical Rod Devices	
	• 2227-F Fire Exit Surface Mounted Vertical Rod Device.....	8
	• 2227-F Fire Exit Surface Mounted Vertical Rod Device Trim	9
Trim Selection	• Optional Trim	10
	• Lever Designs	10
	• Operation Options.....	10
Strike Selection	• Strikes.....	12
	• Strikes/Stiles	12
Device Electrical	• ALK – Exit Alarm kit	15
	• LX – Latch Bolt Monitoring	16
	• RX – Request to Exit	16
	• RX2 – Double Request to Exit.....	16
Device Accessories	• Cover Plate Kit	14
	• Cylinders	11
	• EPT – Electrical Power Transfer	15
	• GBK – Glass Bead Kit	14
	• PS9 – Alarm Kit Power Supply	15
	• Rod and Latch Guards	14
Device Options	• LBR – Less Bottom Rod	14
	• LD – Less Dogging.....	14
	• PL – Pullman Latch	14
Additional Information	• ANSI Grade, Type & Function	13
	• Device, Latch and Rod Dimensions	13
	• UL Fire Labeling and Opening Sizes	13
	• Finishes.....	Inside Cover
	• Handing	13
	• How-to-Order Information.....	18
	• Popular Double Door Applications.....	17
	• Nomenclature	18

Symbols



Indicates Fire Rated Application



Indicates ADA Products

Introduction

Exit devices are a critical part of the Fire and Life Safety egress system and will provide safe and reliable service when properly applied and maintained. Von Duprin designs and manufactures exit devices in accordance to ISO 9001 Quality Management System and meets or exceed accepted U.S. domestic and International standards. All 22 series exit devices are UL listed for Panic Hardware or Fire Hardware, and are certified to ANSI A156.3, 2001, Grade1. Consult your local IR Security & Safety consultant or the Von Duprin factory for current listings.

It is intended that the information included in this publication, when properly used, will provide clear and reliable guidelines to the proper general selection and application. However, the scope of the information is necessarily limited.

Unusual operating conditions and environments and other external influences can affect the proper application of the products represented. Modifications of these products will also affect UL listings. It is recommended that whenever an unusual application condition exists, or when any modification of a product is considered, that our engineers review the application.

Application engineering services are available to help ensure proper selection or to review any areas where users of Von Duprin products may have questions.

VON DUPRIN® 22 Rim Exit Device



299 Strike

22 rim exit device for all types of single and double doors with mullion, UL listed for Panic Exit Hardware. Devices are ANSI A156.3, 2001, Grade 1. Covers stock hollow metal doors with 161* cutouts. Fits door stiles as narrow as 3 13/16" (97mm), see page 12. See opposite page for available outside trim and device functions.

**Not applicable with all strike and mullion combinations, consult factory.*

Specifications

Device Functions	Ships ready for all functions; EO, DT, NL, TP, K, L		
Device Handing	Non-Handed		
Device Lengths	3' (914mm) – see minimum door opening chart at bottom of page 4' (1219mm) – see minimum door opening chart at bottom of page		
Finishes	SP28, SP313		
Strikes	299 Dull Black		
	Optional Strikes		see page 12
Dogging Feature	Hex key dogging standard		
	LD Less Dogging		see page 14
Electric Options	LX Latchbolt Monitor Switch		see page 14
	RX Touch Bar Monitor Switch		see page 14
	RX2 Double Touch Bar Monitor Switch		see page 14
	ALK Alarm Exit Kit		see page 14
Miscellaneous Options	GBK Glass Bead Kit		see page 15
Fasteners & Sex Bolts (SNB)	Includes 1 3/4" (19mm) – 2 1/4" (57mm) Wood & Metal Doors Optional SNB available for device, see next page for quantities		
Latch Bolt	Deadlocking, 3/4" (19mm) throw		
Device Centerline from	39 13/16" (1011mm) at center of device Finished Floor 39 11/16" (1008mm) with Mullion		
Device Dimensions	see page 13		



See page 16 for How to Order specification

Minimum Door Opening Chart



Stop Height	Strike	Single Door	Double Door w/Mullion	Minimum Door Opening for 3' device*	Minimum Door Opening w/ALK*
1/2"	299	Yes	—	26.500" (673mm)	33.250" (845mm)
1/2"	1439	Yes	—	25.687" (652mm)	32.437" (824mm)
1/2"	299	—	4754/4854/4954	27.000" (686mm)	33.750" (857mm)
1/2"	299	—	5654	25.812" (656mm)	32.562" (827mm)
1/2"	1408	—	5754	25.750" (679mm)	32.500" (826mm)
1/2"	1606	—	1654	26.562" (675mm)	33.312" (846mm)
5/8"	299	Yes	—	26.750" (679mm)	33.500" (851mm)
5/8"	1439	Yes	—	25.937" (659mm)	32.687" (830mm)
5/8"	299	—	4754/4854/4954	27.125" (689mm)	33.875" (860mm)
5/8"	299	—	5654	26.687" (678mm)	33.437" (849mm)
5/8"	1408	—	5754	25.875" (657mm)	32.625" (829mm)
5/8"	1606	—	1654	26.687" (678mm)	33.437" (849mm)

*For 4' device, add 6" (152mm)

VON DUPRIN® 22 Rim Exit Device Standard Trim

	Exit only	Dummy Trim Pull when Dogged	Night Latch Key Retracts Latchbolt	Night Latch Key Retracts Latchbolt Optional Pull Required
				
Product Description	22EO	22DT	22NL	22NL-OP
Trim Description	—	210DT*	210NL*	110NL-MD* 110NL-WD*
Escutcheon Plate Size	—	5 ³ / ₈ " x 4 ²⁵ / ₃₂ " x ³ / ₃₂ " (137x121x2mm)	5 ³ / ₈ " x 4 ²⁵ / ₃₂ " x ³ / ₃₂ " (137x121x2mm)	—
Pull Center to Center	—	—	—	—
Projection	—	1 ³¹ / ₃₂ " (42mm)	1 ³¹ / ₃₂ " (42mm)	—
ANSI Function	01	02	03	03
Cylinder Type	—	—	Rim	Rim
Optional Trim (See page 10)	230EO	230DT	230NL	—
Optional #425 Sex Bolt Quantity for Device	6 (with no trim) 2 (with EO trim)	2	2	6

* ANSI/BHMA A156.3 (2001) Grade 1 Trim

	Thumbpiece Key Locks & Unlocks	Knob Key Locks & Unlocks	Lever Key Locks & Unlocks
			
Product Description	22TP	22K	22L
Trim Description	230TP*	210K	230L*
Escutcheon Plate Size	3" x 12 ¹ / ₁₆ " x ³ / ₃₂ " (76x306x2mm)	3" x 4 ²⁵ / ₃₂ " x ³ / ₃₂ " (76x121x2mm)	3" x 6 ³ / ₈ " x 1 ⁵ / ₁₆ " (76x162x24mm)
Pull Center to Center	5 ¹ / ₂ " (140mm)	—	—
Projection	2" (51mm)	2 ¹⁵ / ₁₆ " (75mm)	2 ⁵ / ₈ " (67mm)
ANSI Function	05	08	08
Cylinder Type	1 ¹ / ₄ " Mortise	Furnished	1 ¹ / ₄ " Mortise
Optional Trim (See page 10)	230TP-BE	210K-BE	230L-BE
Optional #425 Sex Bolt Quantity for Device	2	2	2

* ANSI/BHMA A156.3 (2001) Grade 1 Trim

VON DUPRIN® 22-F Rim Fire Exit Device

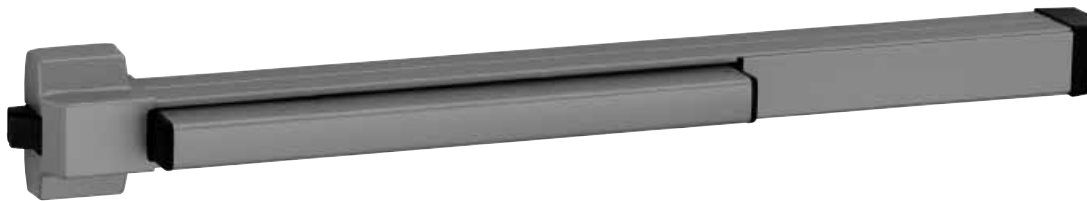

299F Strike



499F Strike
With 9854/9954
Mullion

22-F rim fire exit device for all types of single doors up to 4' x 8' (1219mm x 3048mm) or 8' x 8' (2438mm x 3048mm) double doors with 9954 or 9854 mullion, UL listed for Fire Exit Hardware. **See page 13 for detailed information on UL listed fire exit hardware label and door opening size information.** Devices are ANSI A156.3, 2001, Grade 1. Fits door stiles as narrow as 4 3/8" (111mm), see page 12. See opposite page for available outside trim and device functions.

Specifications

Device Functions	Ships ready for all functions; EO, NL, TP, K, L		
Device Handing	Non-Handed		
Device Lengths	3' (914mm) – see minimum door opening chart at bottom of page 4' (1219mm) – see minimum door opening chart at bottom of page		
Finishes	SP28, SP313		
Strikes	299F – Dull Black, single doors 499F – Dull Black, double door with 9954 or 9854 mullion Optional Strike see page 12		
Dogging Feature	No mechanical dogging		
Electric Options	LX	Latchbolt Monitor Switch	see page 14
	RX	Touch Bar Monitor Switch	see page 14
	RX2	Double Touch Bar Monitor Switch	see page 14
	ALK	Alarm Exit Kit	see page 14
Miscellaneous Options	GBK	Glass Bead Kit	see page 15
Fasteners & Sex Bolts (SNB)	Includes 1 3/4" (19mm) – 2 1/4" (57mm) Wood & Metal Doors Optional SNB available for device, see next page for quantities. Sex bolts are required on wood fire doors.		
Latch Bolt	Deadlocking, 3/4" (19mm) throw		
Device Centerline from	39 13/16" (1011mm) at center of device Finished Floor 39 11/16" (1008mm) with Mullion		
Device Dimensions	see page 13		



See page 16 for How to Order specification

Minimum Door Opening Chart

Stop Height	Strike	Single Door	Double Door w/Mullion	Minimum Door Opening for 3' device*	Minimum Door Opening w/ALK*
1/2"	299F/499F	Yes	—	26.500" (673mm)	33.250" (845mm)
1/2"	299F/499F	—	KR/9854/9954	27.000" (686mm)	33.750" (857mm)
5/8"	299F/499F	Yes	—	26.750" (679mm)	33.500" (851mm)
5/8"	299F/499F	—	KR/9854/9954	27.125" (689mm)	33.875" (860mm)



*For 4' device, add 6" (152mm)

VON DUPRIN® 22-F Rim Fire Exit Device Standard Trim

	Exit only	Night Latch Key Retracts Latchbolt	Night Latch Key Retracts Latchbolt Optional Pull Required
			
Product Description	22EO-F	22NL-F	22NL-OP-F
Trim Description	—	210NL**	110NL-MD** 110NL-WD**
Escutcheon Plate Size	—	5 ³ / ₈ " x 4 ²⁵ / ₃₂ " x ³ / ₃₂ " (137x121x2mm)	—
Pull Center to Center	—	—	—
Projection	—	1 ³¹ / ₃₂ " (42mm)	—
ANSI Function	01	03	03
Cylinder Type	—	Rim	Rim
Optional Trim (See page 10)	230EO	230NL	—
*Optional #425 Sex Bolt Quantity for Device	6 (with no trim) 2 (with EO trim)	2	6
*Additional 425 SNB for 499F strike	2	2	2

* Sex Bolts are required for wood fire doors

** ANSI/BHMA A156.3 (2001) Grade 1 Trim

	Thumbpiece Key Locks & Unlocks	Knob Key Locks & Unlocks	Lever Key Locks & Unlocks
			
Product Description	22TP-F	22K-F	22L-F
Trim Description	230TP**	210K	230L**
Escutcheon Plate Size	3" x 12 ¹ / ₁₆ " x ³ / ₃₂ " (76x306x2mm)	3" x 4 ²⁵ / ₃₂ " x ³ / ₃₂ " (76x121x2mm)	3" x 6 ³ / ₈ " x 1 ⁵ / ₁₆ " (76x162x24mm)
Pull Center to Center	5 ¹ / ₂ " (140mm)	—	—
Projection	2" (51mm)	2 ¹⁵ / ₁₆ " (75mm)	2 ⁵ / ₈ " (67mm)
ANSI Function	05	08	08
Cylinder Type	1 ¹ / ₄ " Mortise	Furnished	1 ¹ / ₄ " Mortise
Optional Trim (See page 10)	230TP-BE	210K-BE	230L-BE
*Optional #425 Sex Bolt Quantity for Device	2	2	2
*Additional 425 SNB for 499F strike	2	2	2

* Sex Bolts are required for wood fire doors

** ANSI/BHMA A156.3 (2001) Grade 1 Trim

VON DUPRIN® 2227 Surface Mounted Vertical Rod Device



2227 surface mounted vertical rod exit device for all types of single and double doors, UL listed for Panic Exit Hardware. Devices are ANSI A156.3, 2001, Grade 1. Covers stock hollow metal doors with 86 or 161 cutouts. Fits door stiles as narrow as 3 5/8" (92mm), see page 12. See opposite page for available outside trim and device functions.

Specifications

Device Functions	Ships ready for all functions; EO, DT, NL, TP, K, L	
Device Handing	Non-Handed	
Device Lengths	3' (914mm) – see minimum door opening chart at bottom of page 4' (1219mm) – see minimum door opening chart at bottom of page	
Door Height	7' (2134mm) – standard door height Extension rods available for door heights up to 10' 12" (205mm) 36" (914mm)	
Finishes	SP28, SP313	
Strikes	Top 299 – Dull Black Bottom 248L-4 and 304L – Unfinished Optional Strikes see page 12	
Dogging Feature	Hex key dogging standard LD Less Dogging see page 14	
Electric Options	LX Latchbolt Monitor Switch see page 14 RX Touch Bar Monitor Switch see page 14 RX2 Double Touch Bar Monitor Switch see page 14 ALK Alarm Exit Kit see page 14	
Miscellaneous Options	PL Pullman Latch see page 14 GBK Glass Bead Kit see page 15 RG Rod Guards see page 15 LG Latch Guards see page 15	
Fasteners & Sex Bolts (SNB)	Includes 1 3/4" (19mm) – 2 1/4" (57mm) Wood & Metal Doors Optional SNB available for device, see next page for quantities. Sex Bolts are furnished standard for top and bottom latches.	
Latch Bolt	Deadlocking Anti-friction Top and Bottom Bolt, 5/8" (16mm) throw	
Device Centerline from Finished Floor	39 13/16" (1011mm)	
Door Undercut	1/4" (7mm) from finished floor recommended, 3/4" (19mm) maximum or 1/8" (3mm) from threshold	
Device Dimensions	see page 13	

See page 16 for How to Order specification

Minimum Door Opening Chart

Stop Height	Strike	Single Door	Double Door w/Mullion	Minimum Door Opening for 3' device*	Minimum Door Opening w/ALK*
1/2"	N/A	Yes	Vert. x Vert.	25.875" (657mm)	32.625" (829mm)
5/8"	N/A	Yes	Vert. x Vert.	26.000" (664mm)	32.750" (832mm)



*For 4' device, add 6" (152mm)





Top Latch

Bottom Latch

VON DUPRIN® 2227 Surface Mounted Vertical Rod Device Trim

	Exit only	Dummy Trim Pull when Dogged	Night Latch Key Retracts Latchbolt	Night Latch Key Retracts Latchbolt Optional Pull Required
				
Product Description	2227EO	2227DT	2227NL	2227NL-OP
Trim Description	—	210DT*	210NL*	110NL-MD* 110NL-WD*
Escutcheon Plate Size	—	5 ³ / ₈ " x 4 ²⁵ / ₃₂ " x ³ / ₃₂ " (137x121x2mm)	5 ³ / ₈ " x 4 ²⁵ / ₃₂ " x ³ / ₃₂ " (137x121x2mm)	—
Pull Center to Center	—	—	—	—
Projection	—	1 ³ / ₃₂ " (42mm)	1 ³ / ₃₂ " (42mm)	—
ANSI Function	01	02	03	03
Cylinder Type	—	—	Rim	Rim
Optional Trim (See page 10)	230EO	230DT	230NL	—
Optional #425 Sex Bolt Quantity for Device	6 (with no trim) 2 (with EO trim)	2	2	6

* ANSI/BHMA A156.3 (2001) Grade 1 Trim

	Thumbpiece Key Locks & Unlocks	Knob Key Locks & Unlocks	Lever Key Locks & Unlocks
			
Product Description	2227TP	2227K	2227L
Trim Description	230TP*	210K	230L*
Escutcheon Plate Size	3" x 12 ¹ / ₁₆ " x ³ / ₃₂ " (76x306x2mm)	3" x 4 ²⁵ / ₃₂ " x ³ / ₃₂ " (76x121x2mm)	3" x 6 ³ / ₈ " x 1 ⁵ / ₁₆ " (76x162x24mm)
Pull Center to Center	5 ¹ / ₂ " (140mm)	—	—
Projection	2" (51mm)	2 ¹⁵ / ₁₆ " (75mm)	2 ⁵ / ₈ " (67mm)
ANSI Function	05	08	08
Cylinder Type	1 ¹ / ₄ " Mortise	Furnished	1 ¹ / ₄ " Mortise
Optional Trim (See pages 10)	230TP-BE	210K-BE	230L-BE
Optional #425 Sex Bolt Quantity for Device	2	2	2

* ANSI/BHMA A156.3 (2001) Grade 1 Trim

VON DUPRIN® 2227-F Surface Mounted Vertical Rod Fire Exit Device

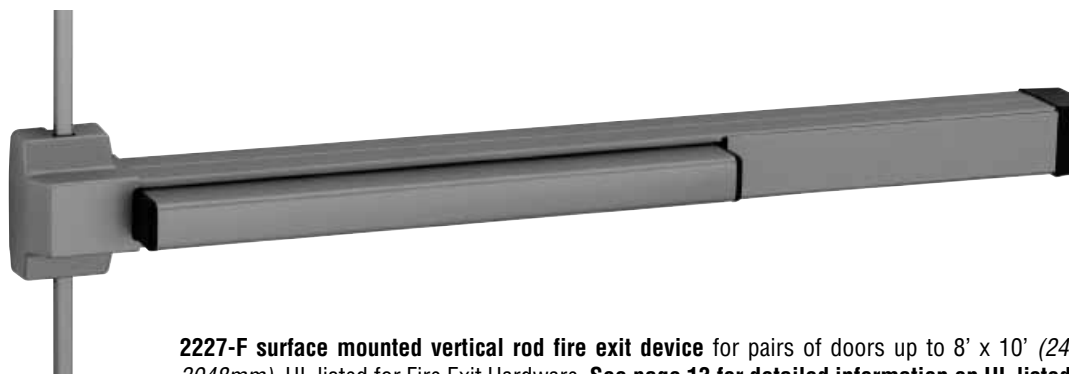

2227-F surface mounted vertical rod fire exit device for pairs of doors up to 8' x 10' (2438mm x 3048mm), UL listed for Fire Exit Hardware. **See page 13 for detailed information on UL listed fire exit hardware label and door opening size information.** Devices are ANSI A156.3, 2001, Grade 1. Fits door stiles as narrow as 3 5/8" (92mm), see page 12. See opposite page for available outside trim and device functions.

Specifications

Device Functions	Ships ready for all functions; EO, NL, TP, K, L	
Device Handing	Non-Handed	
Device Lengths	3' (914mm) – see minimum door opening chart at bottom of page 4' (1219mm) – see minimum door opening chart at bottom of page	
Door Height	7' (2134mm) – standard door height Extension rods available for door heights up to 10' 12" (205mm) 36" (914mm)	
Finishes	SP28, SP313	
Strikes	Top 299F (499F LBR) – Dull Black Bottom 304L – Unfinished Optional Strikes see page 12	
Dogging Feature	No Mechanical Dogging	
Electric Options	LX Latchbolt Monitor Switch	see page 14
	RX Touch Bar Monitor Switch	see page 14
	RX2 Double Touch Bar Monitor Switch	see page 14
	ALK Alarm Exit Kit	see page 14
Miscellaneous Options	LBR Less Bottom Rod	see page 14
	GBK Glass Bead Kit	see page 15
	RG Rod Guards	see page 15
	LG Latch Guards	see page 15
Fasteners & Sex Bolts (SNB)	Includes 1 3/4" (19mm) – 2 1/4" (57mm) Wood & Metal Doors Optional SNB available for device, see next page for quantities. Sex Bolts are furnished standard for top and bottom latches.	
Latch Bolt	Deadlocking Anti-friction Top and Bottom Bolt, 5/8" (16mm) throw	
Device Centerline from Finished Floor	39 13/16" (1011mm) at center of device	
Door Undercut	1/4" (7mm) from finished floor recommended, 3/4" (19mm) 3/8" (9mm) maximum	
Device Dimensions	see page 13	

Top Latch



Bottom Latch

299F Top Strike



304L Bottom Strike



See page 16 for How to Order specification

Minimum Door Opening Chart

Stop Height	Strike	Single Door	Double Door w/Mullion	Minimum Door Opening for 3' device*	Minimum Door Opening w/ALK*
1/2"	N/A	Yes	Vert. x Vert.	25.875" (657mm)	32.625" (829mm)
5/8"	N/A	Yes	Vert. x Vert.	26.000" (664mm)	32.750" (832mm)



*For 4' device, add 6" (152mm)

VON DUPRIN® 2227-F Surface Mounted Vertical Rod Fire Exit Device Trim

	Exit only	Night Latch Key Retracts Latchbolt	Night Latch Key Retracts Latchbolt Optional Pull Required
			
Product Description	2227EO-F	2227NL-F	2227-OP-F
Trim Description	—	210NL**	110NL-MD** 110NL-WD**
Escutcheon Plate Size	—	5 ⁹ / ₈ " x 4 ²⁵ / ₃₂ " x ³ / ₃₂ " (137x121x2mm)	—
Pull Center to Center	—	—	—
Projection	—	1 ³¹ / ₃₂ " (42mm)	—
ANSI Function	01	03	03
Cylinder Type	—	Rim	Rim
Optional Trim (See page 10)	230EO	230NL	—
*Optional #425 Sex Bolt Quantity for Device	6 (with no trim) 2 (with EO trim)	2	6
*Additional 425 SNB for 499F strike	2	2	2

* Sex Bolts are required for wood fire doors

** ANSI/BHMA A156.3 (2001) Grade 1 Trim

	Thumbpiece Key Locks & Unlocks	Knob Key Locks & Unlocks	Lever Key Locks & Unlocks
			
Product Description	2227TP-F	2227K-F	22L-F
Trim Description	230TP**	210K	230L**
Escutcheon Plate Size	3" x 12 ¹ / ₁₆ " x ³ / ₃₂ " (76x306x2mm)	3" x 4 ²⁵ / ₃₂ " x ³ / ₃₂ " (76x121x2mm)	3" x 6 ³ / ₈ " x 1 ⁵ / ₁₆ " (76x162x24mm)
Pull Center to Center	5 ¹ / ₂ " (140mm)	—	—
Projection	2" (51mm)	2 ¹⁵ / ₁₆ " (75mm)	2 ⁵ / ₈ " (67mm)
ANSI Function	05	08	08
Cylinder Type	1 ¹ / ₄ " Mortise	Furnished	1 ¹ / ₄ " Mortise
Optional Trim (See page 10)	230TP-BE	210K-BE	230L-BE
*Optional #425 Sex Bolt Quantity for Device	2	2	2
*Additional 425 SNB for 499F strike	2	2	2

* Sex Bolts are required for wood fire doors

** ANSI/BHMA A156.3 (2001) Grade 1 Trim

210 Series Trim

The 210DT and 210NL have a heavy 10 gauge (2.4mm) stainless steel escutcheon. Cylinder must be ordered separately for the 210NL trim. The 210K knob trim has a 10 gauge (2.4mm) steel escutcheon and uses the Schlage "A" orbit knob with six pin "C" keyway.

230 Series Trim

The 230EO, 230DT, 230NL and 230TP have a heavy 10 gauge (2.4mm) steel escutcheon. The 230L has a cast aluminum 3/4" (19mm) depth escutcheon. #06 lever style furnished standard, #03 style lever is available. 230L furnished RHR if handing is not specified. Cylinder must be ordered separately for the 230NL, 230TP and 230L trims.

110NL Cylinder Kit

Cylinder kit is available MD for metal doors or WD for wood doors. Metal door application supplied standard if door material is not specified. When ordering with device, specify function NL-OP. Cylinder must be ordered separately.

	Exit Only Trim Plate	Dummy Trim Pull When Dogged	Night Latch Key Retracts Latch Bolt	Thumbpiece Blank Escutcheon Always Operable, no cylinder	Lever Blank Escutcheon Always Operable, no cylinder	Knob Blank Escutcheon Always Operable, no cylinder
Trim Description	230EO	230DT**	230NL**	230TP-BE**	230L-BE**	210K-BE
Escutcheon Plate Size	3" x 12 1/16" x 3/32" (76x306x2mm)	3" x 12 1/16" x 3/32" (76x306x2mm)	3" x 12 1/16" x 3/32" (76x306x2mm)	3" x 12 1/16" x 3/32" (76x306x2mm)	3" x 6 3/8" x 15/16" (76x162x24mm)	3" x 4 25/32" x 3/32" (76x121x2mm)
Pull Center to Center	—	5 1/2" (140mm)	5 1/2" (140mm)	5 1/2" (140mm)	—	—
Projection	—	2" (51mm)	2" (51mm)	2" (51mm)	2 5/8" (67mm)	2 15/16" (75mm)
ANSI Function	01	02	03	—	—	—
Cylinder Type	—	—	Rim	—	—	—
*Optional #425 Sex Bolt Quantity for Device	2	2	6	—	2	2
*Additional 425 SNB for 499F strike	2	2	2	2	2	2

* Sex Bolts are required for wood fire doors

** ANSI/BHMA A156.3 (2001) Grade 1 Trim

Operation Options

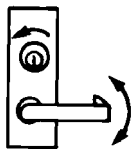

Standard operation,
key locks and unlocks
lever or knob.
(Classroom)

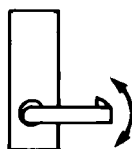

Blank escutcheon,
lever or knob always
active.
(Passage)

Lever Designs



#03



#06
Standard

Cylinders

Cylinders are not furnished with device or trim (unless noted) and must be specified when ordering. Specify finish when ordering separately. Only available with Schlage "C" Keyway. Custom Keying not available.

Rim – 3216

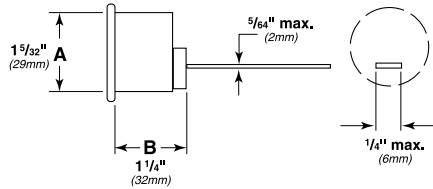

Mortise – 3215 (Schlage B502-191 cam)

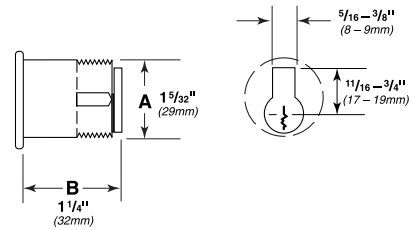

Strikes for Rim Devices

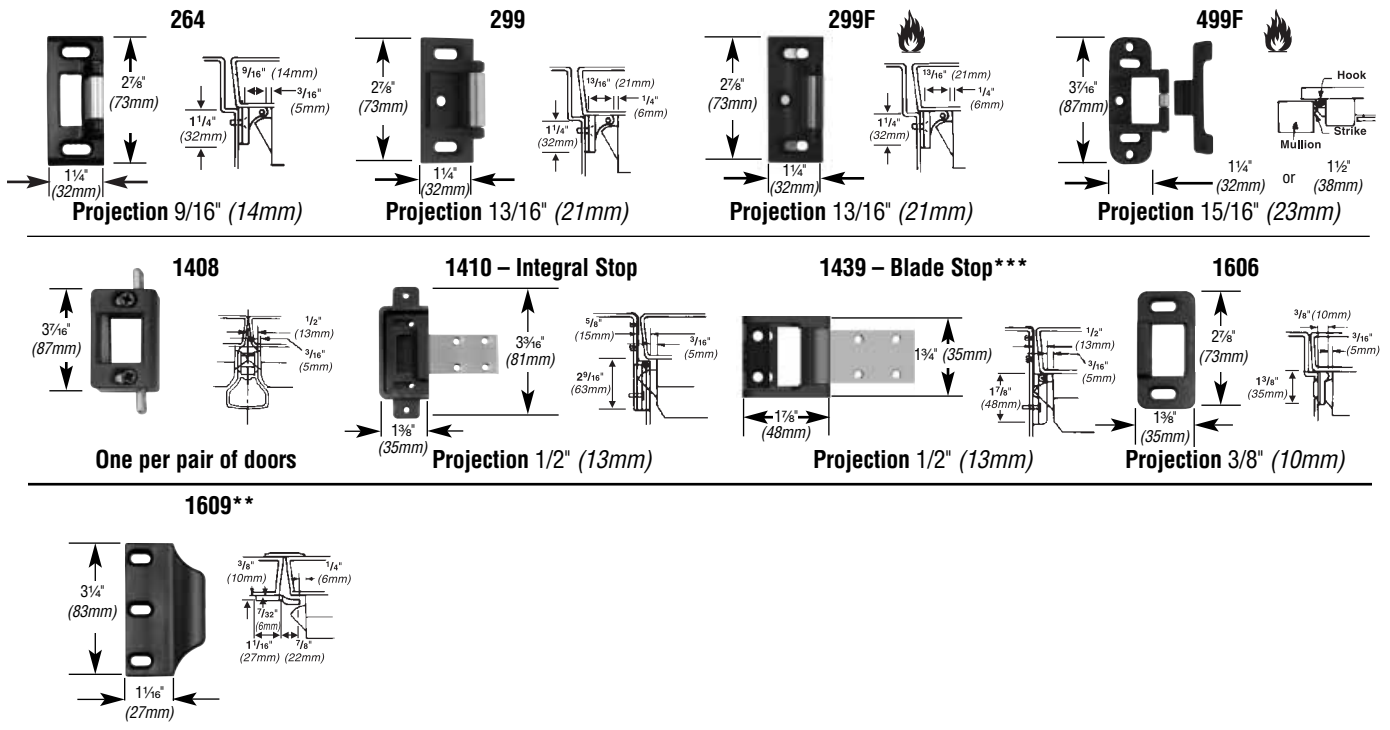

Strikes for Vertical Rod Devices

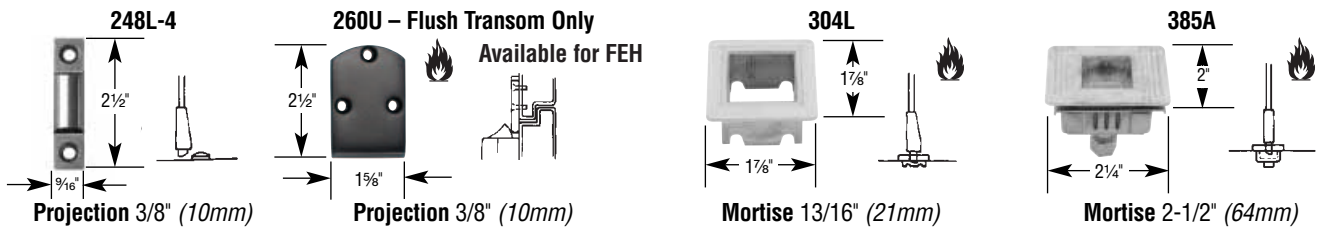

Strikes 264, 299, 299F and 499F also available for Vertical Rod Devices

DEVICE TYPE	STANDARD SINGLE DOOR		STANDARD DOUBLE DOOR		OPTIONAL SINGLE DOOR		OPTIONAL DOUBLE DOOR	
	STRIKE	STILE	APPLICATION*	STILE	STRIKE	STILE	APPLICATION*	STILE
22	299	4-3/4" (121mm)	299 w/4954	4-3/4" (121mm)	1439	3-3/16" (97mm)	299 w/5654	4-1/4" (108mm)
					1410	3-3/16" (97mm)	1408 w/5754	3-3/16" (97mm)
					1606	3-15/16" (100mm)	1606 w/1654	4-1/4" (108mm)
					—	—	1609 w/vertical rod**	4-3/8" (111mm)
22-F	299F	4-3/8" (111mm)	499F w/9954	4-7/8" (124mm)	—	—	—	—
2227 LATCH RETRACTION	299 Top 304L Bottom or 248L4 Bottom	3-5/8" (92mm)	Two Vertical Rods	3-5/8" (92mm)	260U Top 385A Bottom	3-5/8" (92mm)	Two Vertical Rods	3-5/8" (92mm)
2227 PULLMAN LATCH	299 Top 248L4 Bottom	3-5/8" (92mm)	Two Vertical Rods	3-5/8" (92mm)	260U Top	3-5/8" (92mm)	Two Vertical Rods	3-5/8" (92mm)
2227-F	299F Top 304L Bottom	3-5/8" (92mm)	Two Vertical Rods	3-5/8" (92mm)	—	—	—	—

*Mullion information, refer to General and Auxiliary Catalog.

**Not for UL Fire Exit Hardware. Must be used with a coordinator.

*** Replaces 1409 Strike

NOTE: On a Rim/Vertical Rod application for a pair of doors, the 1609 strike extends off the edge of the door into the opening.

UL Listed Fire Exit Hardware Label and Opening Size

Exit Device	Door Material	Double Door							
		Single Door		With Mullion		**Same Direction		Double Egress	
22-F	HM	3 Hour	4' x 8'	3 Hour	8' x 8'	—	—	—	—
22-F	WD	90 MIN.	4' x 8'	90 Min.	8' x 8'	—	—	—	—
2227-F	HM	—	—	—	—	90 Min.	8' x 10'	3 Hour	8' x 10'
2227-F	WD	—	—	—	—	*20 Min.	8' x 10'	*90 Min.	8' x 9'
2227-F	WD	—	—	—	—	*90 Min.	8' x 9'	—	—
2227-F-LBR	HM	—	—	—	—	90 Min.	8' x 10'	3 Hour	8' x 10'
2227-F-LBR	WD	—	—	—	—	*20 Min.	8' x 10'	*90 Min.	8' x 9'
2227-F-LBR	WD	—	—	—	—	*90 Min.	8' x 9'	—	—

*UL listing for wood doors may be for a specific door manufacturer. Consult wood door manufacturers for current UL listings

**Currently, no door manufacturer offers a listing over 90 minutes with doors swinging same direction.

ANSI Grade, Type & Function

Function	Grade 1, Type 1	Grade 1, Type 2
01	22E0, 22E0-F	2227E0, 2227E0-F
02	22DT	2227DT
03	22NL, 22NL-F	2227NL, 2227NL-F
05	22TP, 22TP-F	2227TP, 2227TP-F
08	22K, 22K-F	2227K, 2227K-F
08	22L, 22L-F	2227L, 2227L-F

Door Handing

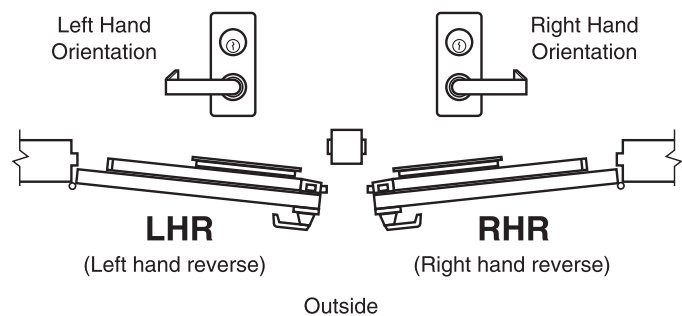

Vertical Rod Dimensions

Vertical rods are 1/2" (13mm) square tubing

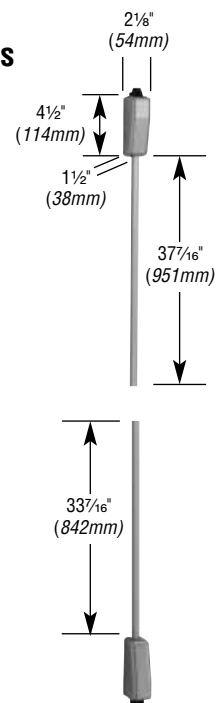

Dimensions

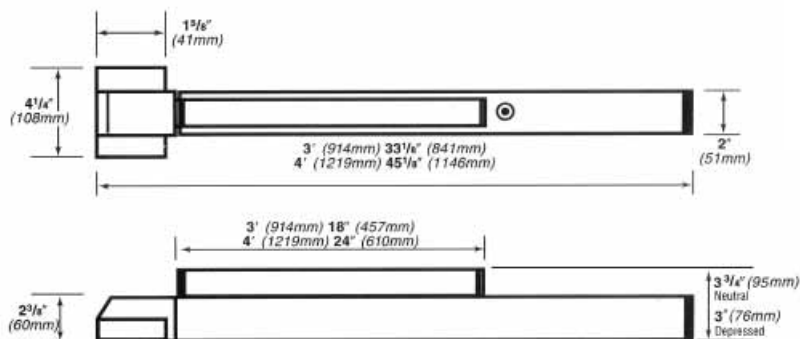

Less Bottom Rod – LBR

LBR option for fire exit devices is available using a spring loaded auxiliary latch bolt installed in the lower door edge. When exposed to heat the auxiliary latch bolt releases, keeping the doors in alignment and closed during a fire. See page 13 for detailed information on UL listed fire exit hardware label and door opening size information.

LBR devices for fire exit devices ship standard with a 499F top strike and less bottom strike.

LBR devices must be ordered in pairs of vertical rod devices, or must be used in conjunction with an approved automatic or constant latching flush bolt.

Less Dogging – LD

Less dogging is available on all 22 series panic exit devices. To order, use prefix LD. Example LD22EO

Pullman Latch – PL

Pullman latches are always extended and are most commonly used in conjunction with electric strikes and LBR-less bottom rod applications. Not available with fire rated exit devices. Pullman latches do not deadlock and are not recommended for applications where security may be compromised. When the PL is specified the standard latches are replaced with Pullman style latches at an additional charge. See Pricebook for details.

Glass Bead Kit – GBK

Glass Bead kits are used on doors with raised glass beads. Each kit consists of $\frac{1}{4}$ " (6mm) shim sets. GBK for surface vertical rod devices ship with $\frac{1}{8}$ " (3mm) shims for rod guides. Shims are not required for Top and Bottom latches

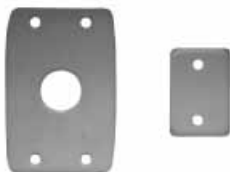

To order, specify:

1. With device specify GBK in device description.
2. To order separately, specify model 22GBK-R (rim), 22GBK-499F (rim), 22GBK-SV (vertical rod)
3. Finish, SP28 or SP313

Cover Plate Kit – 229

Kit contains inside and outside plates for hinge stile cutouts, an inside plate for the lock stile, and necessary screws. Plates are designed to cover cutouts required by most existing exit device installations.

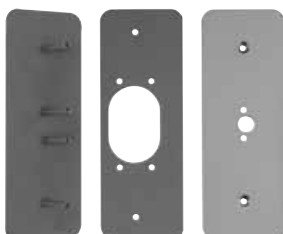

Vertical Rod and Latch Guard — RG-27

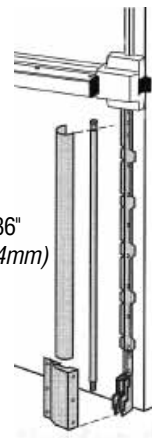

Rod Guard

Series RG-27 Vertical Rod and Latch Guards protect the bottom rods of exit devices from the damaging impacts of carts or gurneys passing through doors. If bottom rods become damaged, the exit device will not function as intended and can jeopardize the ability to exit safely during an emergency.

In addition to protecting the vertical rod, the guard provides a smooth, unobstructed surface so the door can be pushed open easily with the bumpers of a wheelchair. The standard latch guard features a 45° ramp and continuous ramp on full width or extended latch guard.

All stainless steel construction in US32D finish. Latch guards can cover latches as large as $1\frac{1}{4}$ "W x 10"H x $1\frac{7}{8}$ " projection. For use on Hollow Metal Fire-Rated Doors.

33 $\frac{1}{8}$ " (841mm) – 3' (914mm) door
45 $\frac{1}{8}$ " (1146mm) – 4' (1219mm) door

12" (305mm)

2 $\frac{1}{4}$ " (57mm)

Extended Latch Guard

10" (254mm)

4 $\frac{3}{8}$ " (111mm)

Latch Guard

Models

- RG0** — Rod guard only (Projection $1\frac{3}{8}$ " (30mm)).
- RG-27** — Rod and latch guard.
- RG-27-3** — 3' (914mm) Rod Guard and Extended Latch Guard.
- RG-27-4** — 4' (1219mm) Rod Guard and Extended Latch Guard.

- LGO** — Latch guard only.
- LGO-3** — 3' (914mm) Extended latch guard only.
- LGO-4** — 4' (1219mm) Extended latch guard only.

Note: Not for use on wood fire doors

To Order, Specify:

1. Model number.
2. Handing (except on RG0).
3. Door material if other than Hollow Metal.
4. Optional sex bolt mounting available.

Alarm Kit – ALK



The ALK battery alarm kit is a simple yet effective way to deter unauthorized use of an opening. While the exit device is still a means of egress, the ALK kit contains an internal horn. When the touch bar is depressed, the horn sounds to provide an audible means of signaling that the opening has been violated. The alarm kit can be armed or disarmed by key thus allowing the exit device to be set in an armed or disarmed mode. The horn is rated at 85 decibel. Standard Hex Key dogging not available when using an ALK.

The key switch uses a standard 1¼" (32mm) mortise cylinder with a straight cam (Schlage Cam reference B502-191). The unit operates on one standard 9-volt alkaline battery. When the battery is weak, the horn will emit an intermittent low battery alert signal.

Alarm kits are furnished standard with a RX-request to exit switch. Optional LX-Latch bolt monitoring, or RX2-double request to exit monitor switch are available. LX latch bolt monitoring is recommended for use with surface vertical rod exit devices.

The ALK includes "EMERGENCY EXIT ONLY, ALARM WILL SOUND" decal for application on the door.

The ALK is available with two optional circuit boards. External Inhibit (EI) allows for the use of external switch to be used to arm, disarm and reset the alarm. Auto Reset (AR) rearms the alarm after a preset time. Auto Reset is available in three factory set times, 1½, 3 or 6 minutes.

The ALK can also be hard wired and powered using a PS9 power supply. See PS9 on this page for additional information.

To Order, Specify:

1. With device, specify ALK
2. To order separately, specify model 22ALK
3. Specify Options EI or AR, Example: ALK-AR. For AR option specify factory set time (1½, 3 or 6 minutes)
4. Door size other than 3'
5. Switch if other than RX
6. Finish, SP28 or SP313

Minimum door opening sizes on ALK applications – refer to device pages 2, 4, 6 and 8.

Power Supply – PS9

The PS9 is an AC power supply that provides 9 VDC power to operate the ALK alarm kit. The unit will power one or two alarm kits. Included is a 9-volt sealed battery that provides backup power in case of an AC power failure.



Electrical Power Transfer – EPT



UL Listed (GVUX) – Miscellaneous Fire Door Accessories

Electric Power Transfer provides a means of transferring electrical power from a door frame to the edge of a swinging door. The units are completely concealed when the door is in the closed position, and are ideally suited for installations involving abuse or heavy traffic.

Two models are available; EPT-2, two 18 gauge wires and EPT-10, ten 24 gauge wires.

Door applications:

- up to 5" butt hinge – 180° swing
- 5½" butt hinge – 130° swing
- 6" butt hinge – 110° swing
- ¾" offset pivot – 180° swing

Not for use with swing clear hinges or center hung pivots

Finishes

SP28 (sprayed aluminum)
or SP313 (sprayed duranodic).

Dimensions

Housing	9" x 1 ¼" x 1 5/8" (229mm x 32mm x 38mm)
EPT-2	Two 18 gauge wires Up to 2 amps @ 24 VDC with a 16 amp maximum surge
EPT-10	Ten 24 gauge wires, Up to 1 amp @ 24VDC with a 16 amp maximum surge

To order, specify:

1. EPT-2 or EPT-10.
2. Finish, SP28 or SP313.

Request to Exit — RX



The RX (Request to Exit) feature is used to signal the use of an opening. This device is equipped with one internal SPDT switch which monitors the pushpad.

The device can be connected to a security console, or may be used as a single door alarm when used with a horn and power supply. A continuous current electric transfer must be used for transferring power from the frame to the door.

The RX switch option should not be used to control a load, but as a signaling switch (0.5 amps. resistive maximum).

The RX switch is available in a low current (LC) switch. Most commonly used in computer operated monitoring systems.

To Order, Specify:

1. Standard – Use prefix RX, example RX22EO
2. Low Current – Use prefix RX-LC, example RX-LC22EO

Double Request to Exit — RX2

The RX2 feature uses 2 RX switches.

To Order, Specify:

1. Standard – Use prefix RX2, example RX22EO

Latch Bolt Monitoring — LX

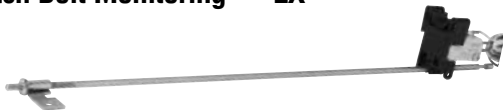

The LX feature is used to signal the use of an opening. This device is equipped with one internal SPDT switch which monitors the latch bolt.

The device can be connected to a security console, or may be used as a single door alarm when used with a horn and power supply. A continuous current electric transfer must be used for transferring power from the frame to the door.

The LX switch option should not be used to control a load, but as a signaling switch (0.5 amps. resistive maximum).

The LX switch is available in a low current (LC) switch. Most commonly used in computer operated monitoring systems.

To Order, Specify:

1. Standard – Use prefix LX, example LX22EO
2. Low Current – Use prefix LX-LC, example LX-LC22EO

Electrical Rating for all Switches:

- Standard – up to 0.5 Amp @ 24VDC Maximum
- Low Current (LC) - up to .05 Amp @ 24VDC Maximum

Note: All Switches can be either factory or field installed

Popular Double Door Applications

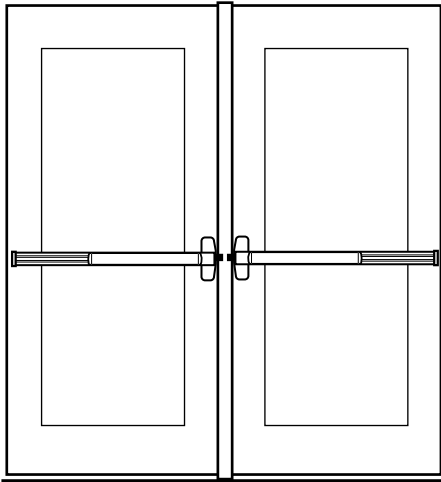

Two rim devices with mullion—
same direction, panic or fire device

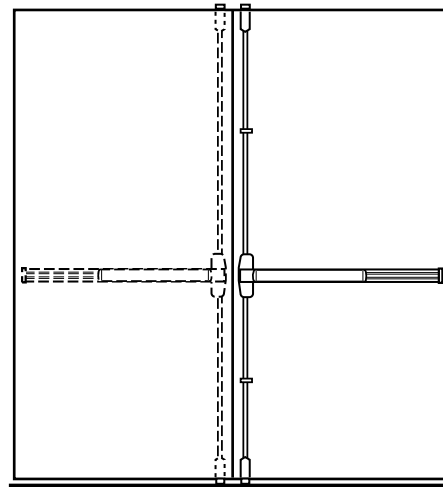

Two vertical rods—double egress, panic or fire
device

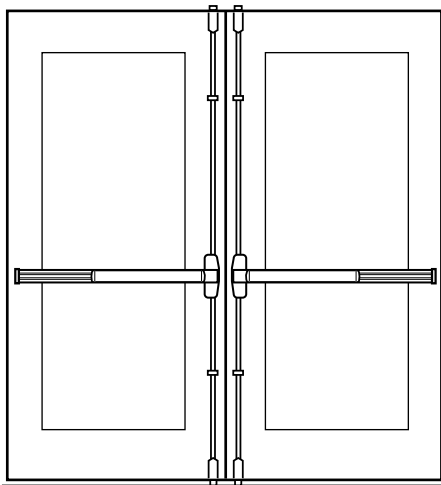

Two surface mounted vertical rod
devices—same direction, panic or fire device
(do not use with overlapping astragal)

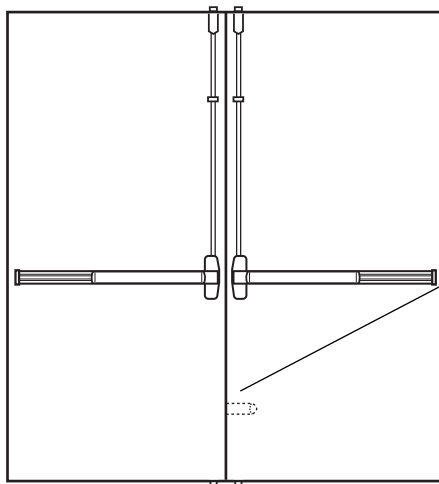

Auxiliary Fire Latch

 Two FEH vertical rods with auxiliary fire latch—
LBR option

Nomenclature – How To Order

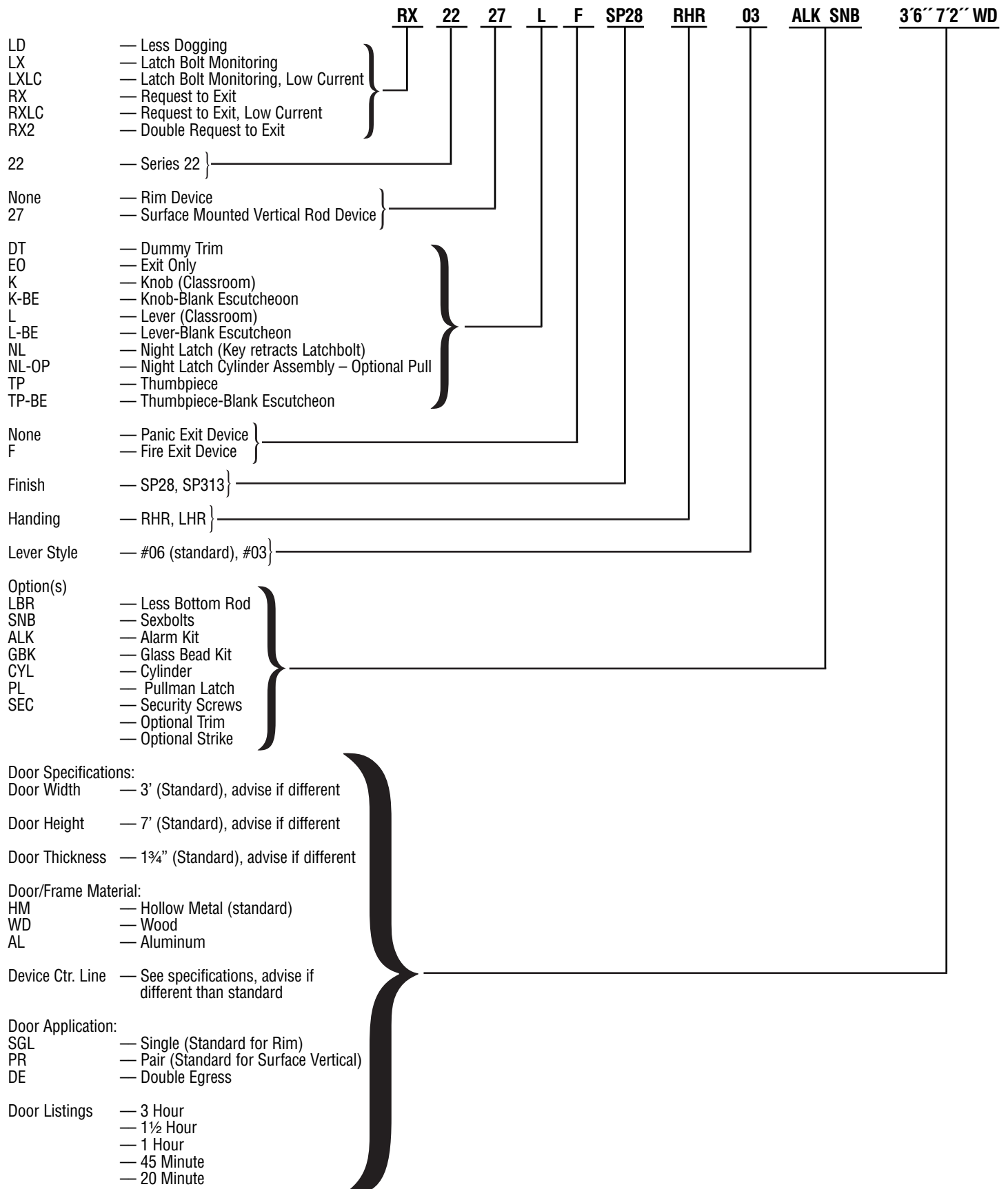

VON DUPRIN®

22 Series Exit Devices

International Offices

Canada / Latin America

IR Security & Safety
1076 Lakeshore Road East
Mississauga, Ontario,
L5E 1E4, Canada
(905) 403-1800
(905) 278-1413 FAX
(877) 590-4734

North-East Asia

IR Security & Safety
23/F, 625 King's Road
Northpoint, Hong Kong
+(852) 2235-0600
+(852) 2565-1409 FAX

South-East Asia / Australia / NZ

IR Architectural Hardware Ltd.
P.O. Box 19-347
437 Rosebank Road,
Avondale, Auckland, New Zealand
+64 (0) 9-829-0550
+64 (0) 9-829-0552 FAX
www.irarchitecturalhardware.co.nz

Mexico

IR Security & Safety
Blvd. Centro Industrial No. 11
Puentes de Vigag, Tlalnepantla
Estado de Mexico, 54070 Mexico
+525-5-8503-6614

Europe / Middle-East / Africa

IR Security & Safety Ltd.
Bescot Crescent
Walsall, West Midlands WS1 4DL
United Kingdom
+44 (0)1922 707400
+44 (0)1922 646303 FAX
www.irsecurityandsafety.co.uk



Visit Von Duprin on the web
www.vonduprin.com
or contact an
IR Security & Safety Consultant
1-877-840-3621



VON DUPRIN

Administrative Offices
2720 Tobey Dr.
Indianapolis, IN 46219
317-613-8944
317-613-8302 Fax

Customer Service
800-999-0408
800-999-0328 Fax

Technical Support
888-371-7331
317-613-8509 Fax

An **IR Ingersoll Rand** business